

TECHNICAL DRAWINGS CAMARGUE SKYE

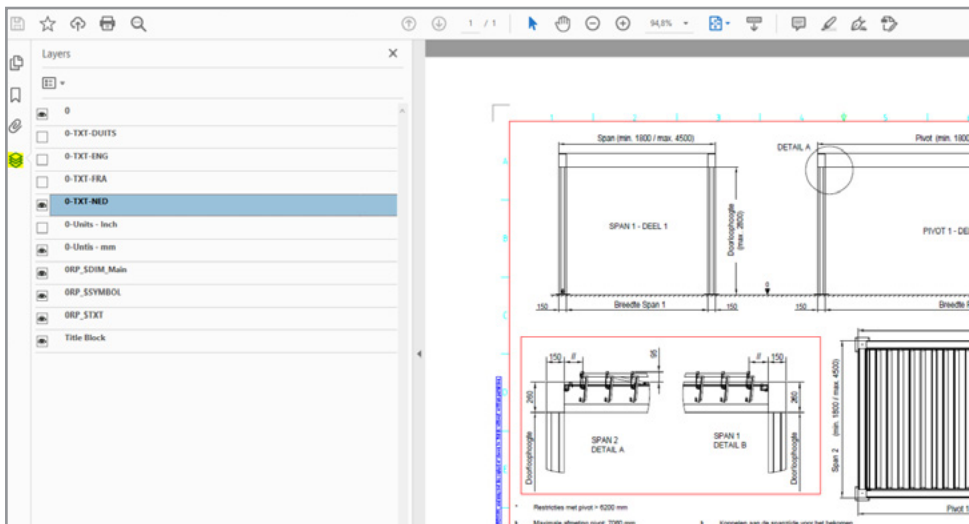

ABOUT THIS DOCUMENT

This interactive PDF offers all the Camargue Skye technical drawings. On the next page you will find the index page with an overview of all available drawings. Click on the titles and you will be redirected to the correct page. When going through the drawings you'll find on the right bottom the Renson logo which leads you back to the index page. Next to that, each drawing has a link to download the PDF or DWG file.



HOW TO TURN ON/OFF LANGUAGES AND DIMENSION LAYERS

- in PDF viewer

When opening the pdf document, notice several layers are standing over each other. Go to the left side of the pdf and click on the tab called 'layers'. A menu will appear with the different language and dimension layers. Turn layers on and off by clicking on the eye-icon next to the name of the layer.

- in Autocad

Go to the 'layout' tab at the topbar. A menu will appear with the different layers. Turn layers on and off by clicking on the lightbulbs next to the name of the layer.

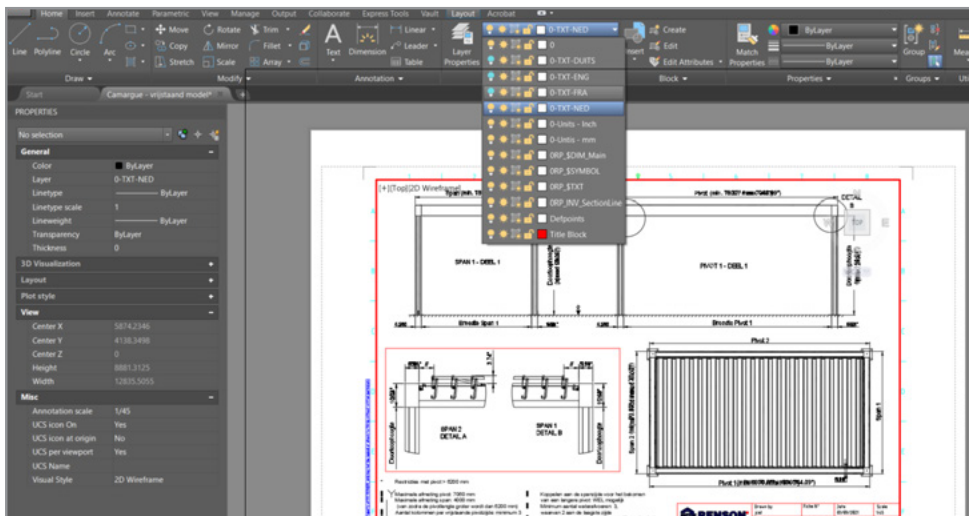

INDEX

Construction Camargue Skye

Freestanding

Façade mounting span

Façade mounting pivot

2 parts coupled
at span and pivot side

3 parts coupled
at span and pivot side

Span section

Couple span section

Pivot section

Couple pivot section

Wall fixation

Visible mounting base

Visible mounting base -
corner

Invisible mounting base

Visible mounting base
reinforced

Visible mounting base
reinforced - corner

Invisible mounting base
reinforced

Water drainage

Adjustable wall column

Accessories Camargue Skye

Integrated fixscreen -
stand alone span side

Integrated fixscreen -
stand alone pivot side

Integrated fixscreen -
façade mounting span

Integrated fixscreen -
façade mounting pivot

Outdoor loggia -
fixed panels

Outdoor loggia -
2 sliding panels

Outdoor loggia -
4 sliding panels

Outdoor loggia -
6 sliding panels

Glass sliding panels
- stand alone 4 tracks

Glass sliding panels -
façade mounting 3 tracks

Glass sliding panels
- stand alone 5 tracks

Linus wall - double sided

Linus wall - single sided

Linus wall -
double sided as railing

Linarte wall - linarte canvas

Linarte wall -
linarte without finish

Camargue Skye - FREESTANDING

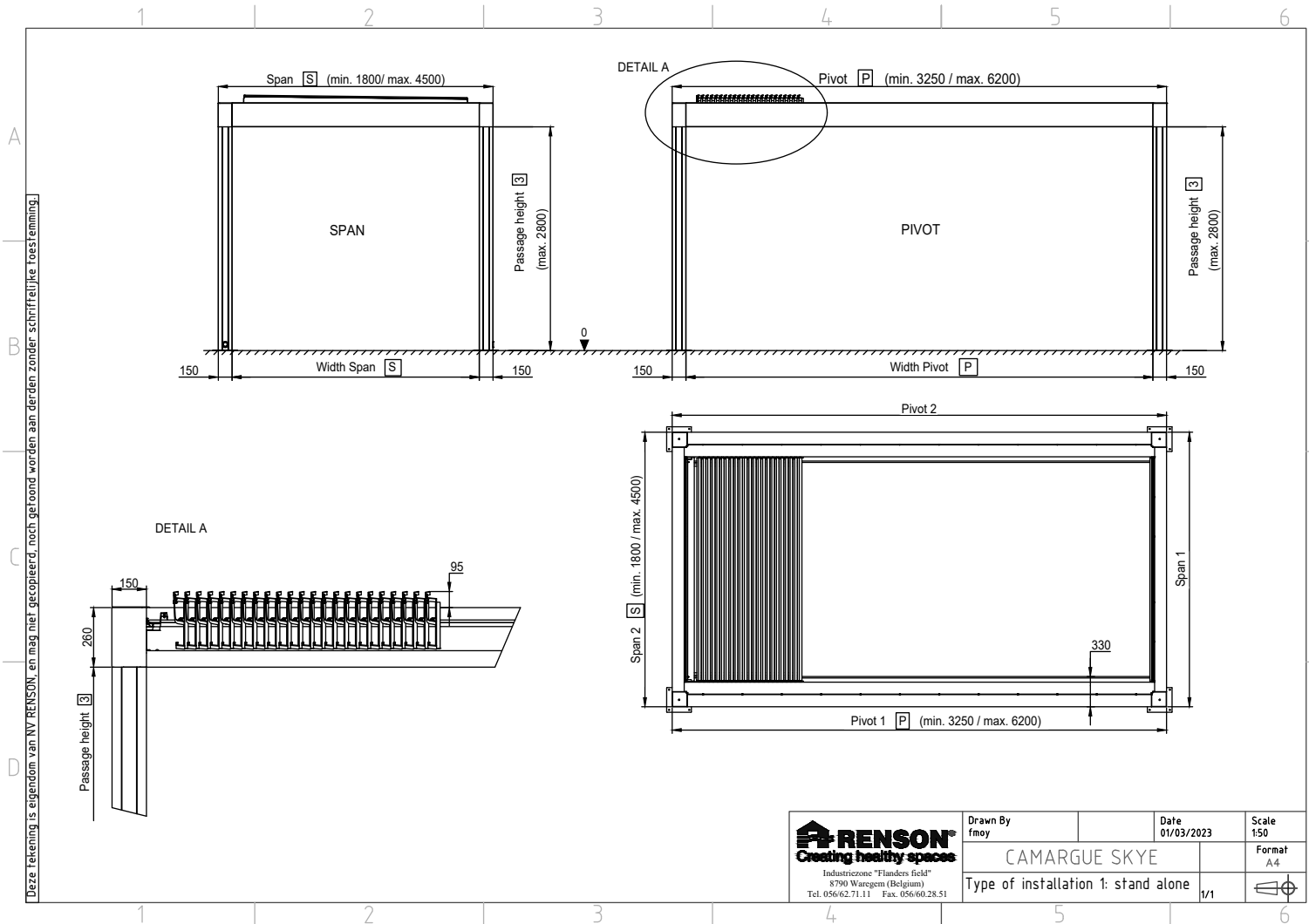

Download this drawing DWG

Download this drawing PDF

Camargue Skye - FAÇADE MOUNTING SPAN

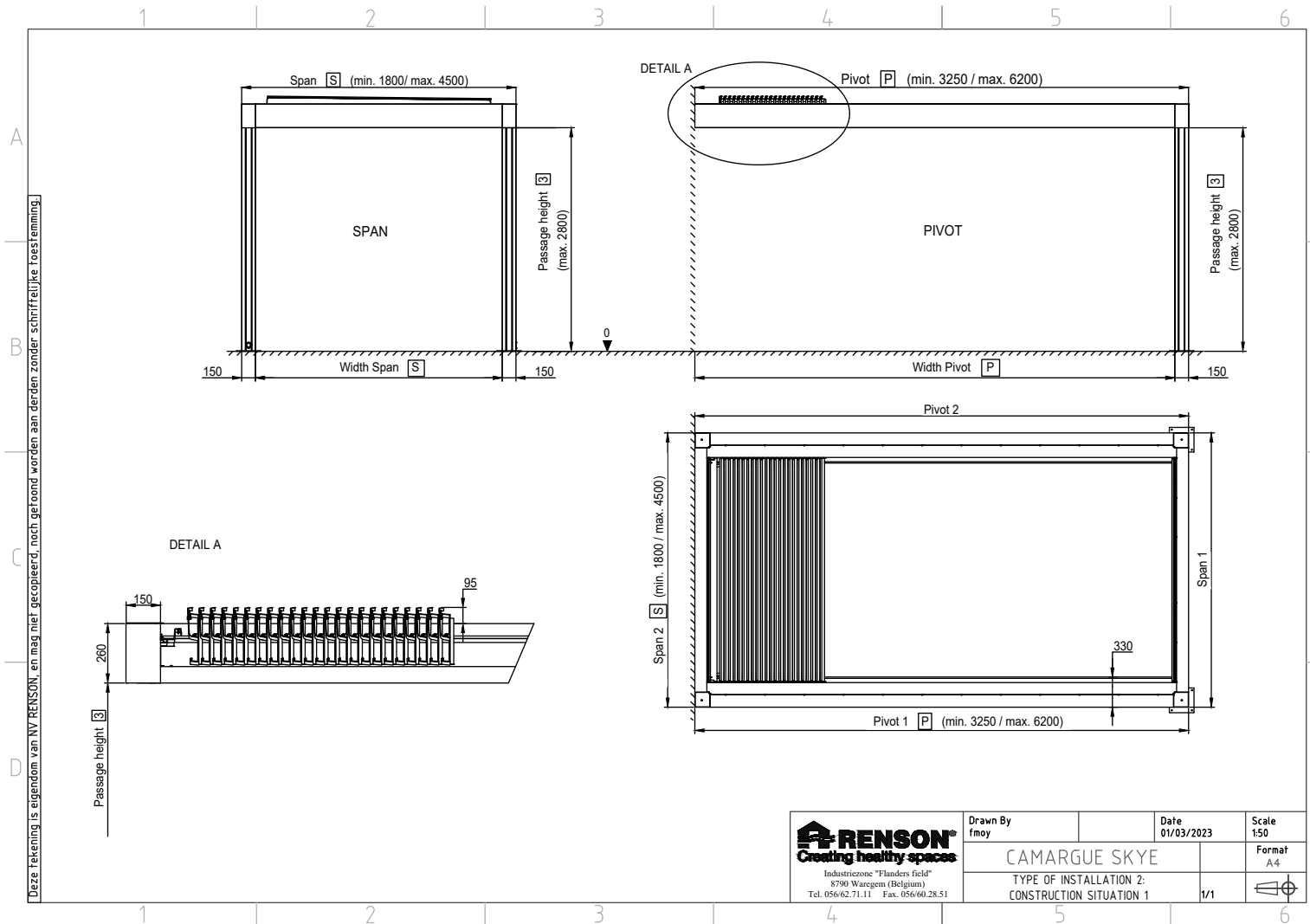

Download this drawing DWG

Download this drawing PDF

Camargue Skye - FAÇADE MOUNTING PIVOT

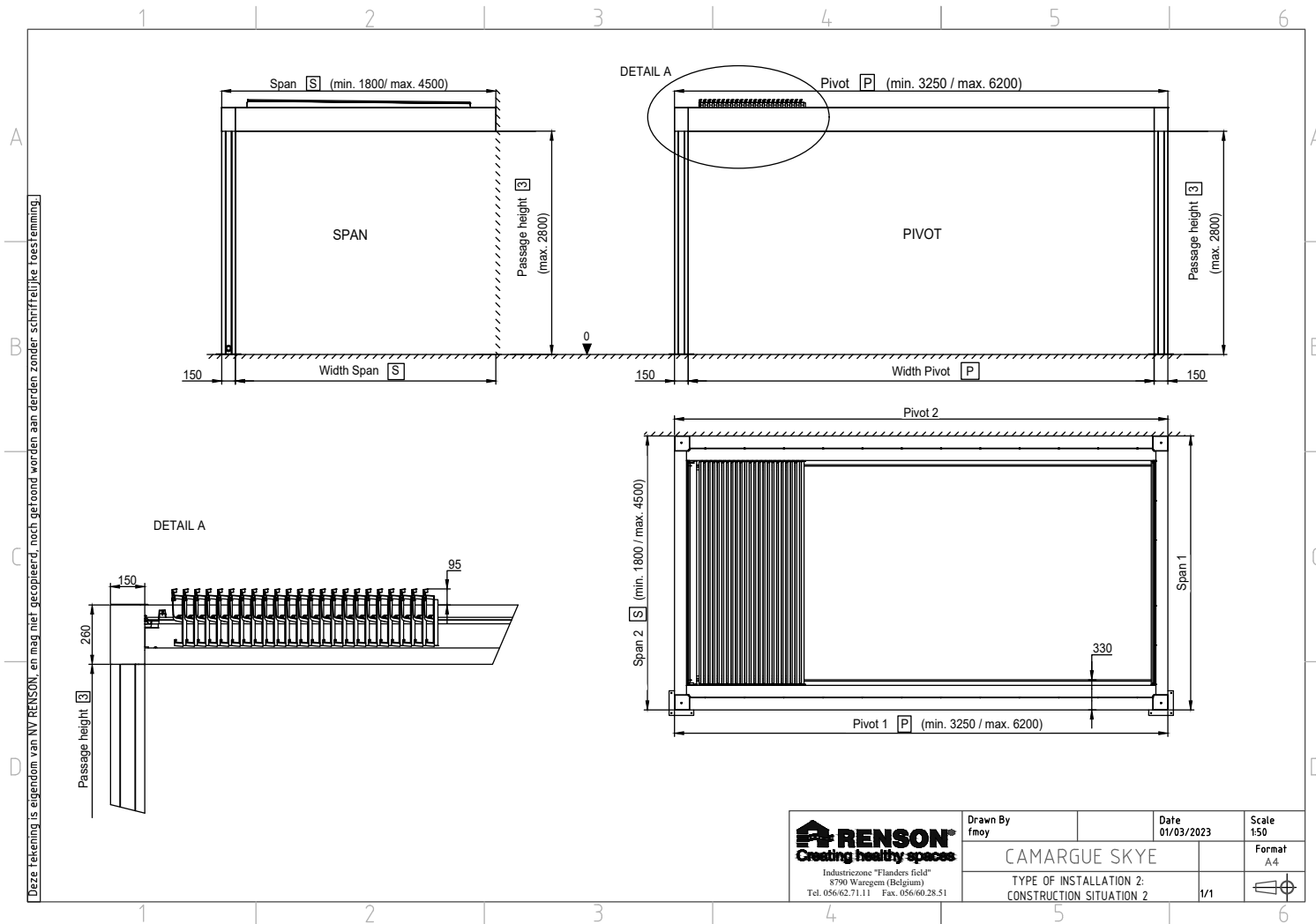

Deze tekening is eigendom van NV RENSON, en mag niet gecopieerd, noch getoond worden aan derden zonder schriftelijke toestemming.

 RENSON Creating healthy spaces Industriezone "Flanders field" 8790 Waregem (Belgium) Tel. 056/62.71.11 Fax. 056/60.28.51	Drawn By fmoy	Date 01/03/2023	Scale 1:50
	CAMARGUE SKYE TYPE OF INSTALLATION 2: CONSTRUCTION SITUATION 2		Format A4 1/1

Download this drawing DWG

Download this drawing PDF

Camargue Skye - 2 PARTS COUPLED AT SPAN AND PIVOT SIDE

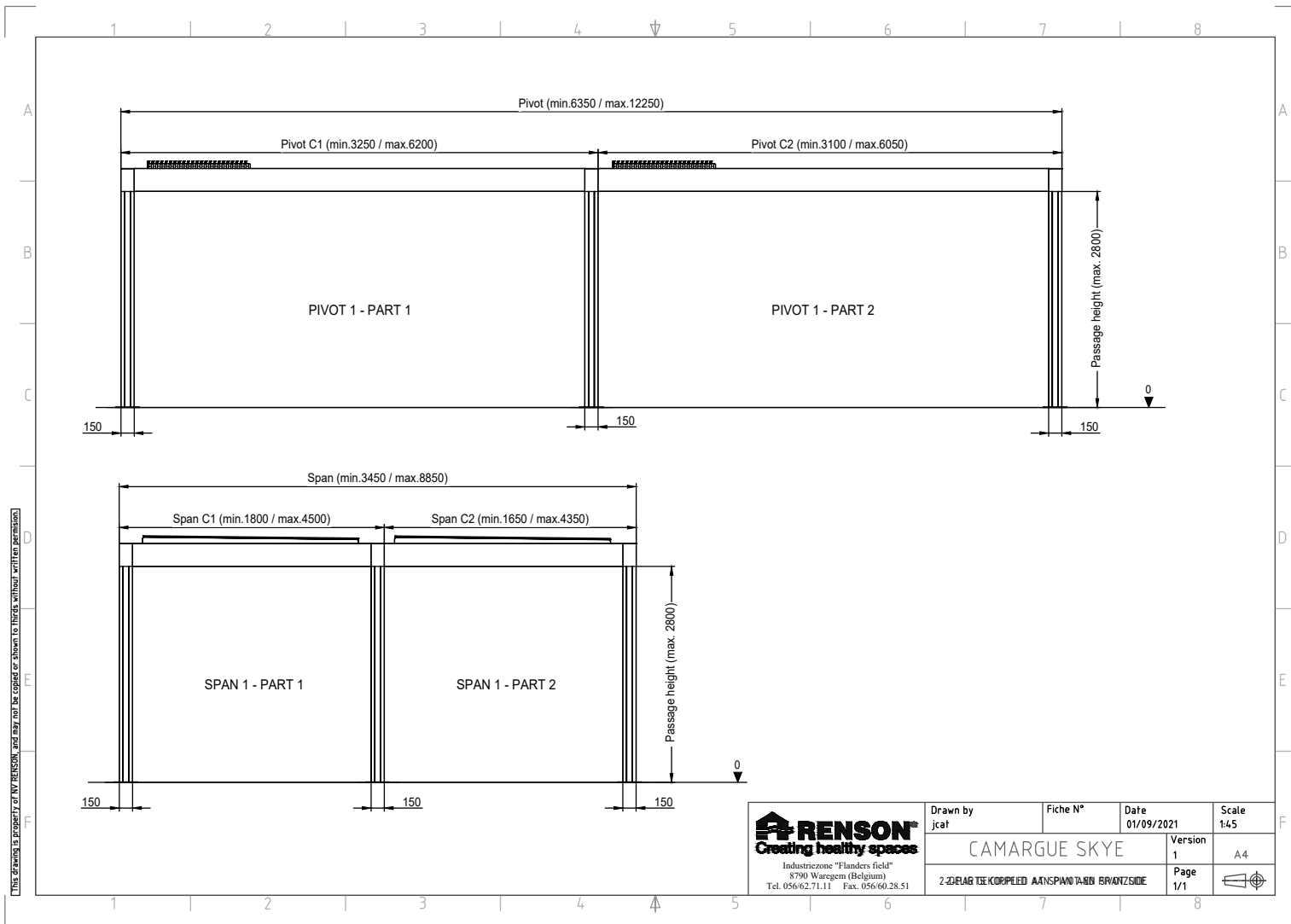

Download this drawing DWG

Download this drawing PDF

Camargue Skye - 3 PARTS COUPLED AT SPAN AND PIVOT SIDE

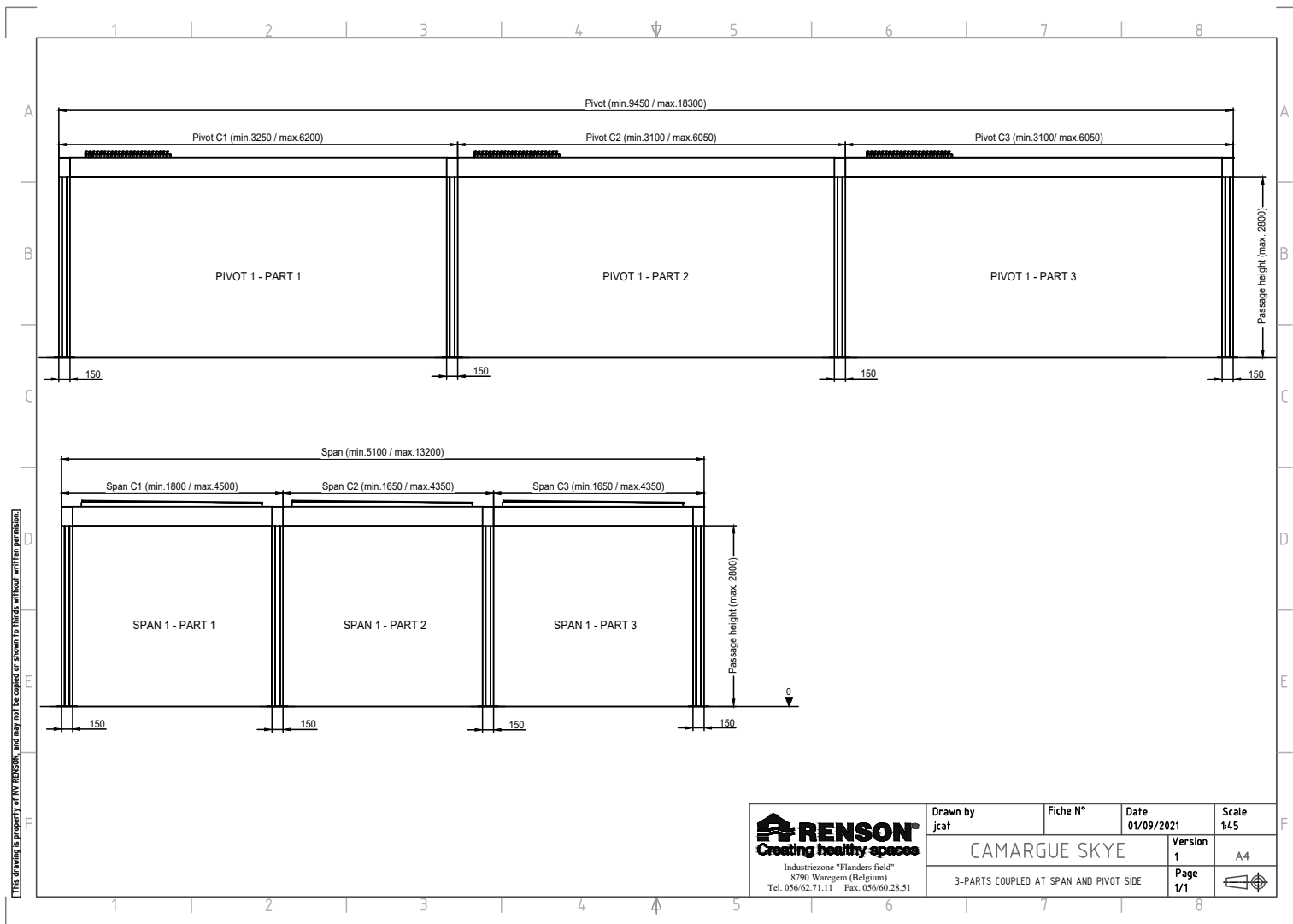

Download this drawing DWG

Download this drawing PDF

Camargue Skye - SPAN SECTION

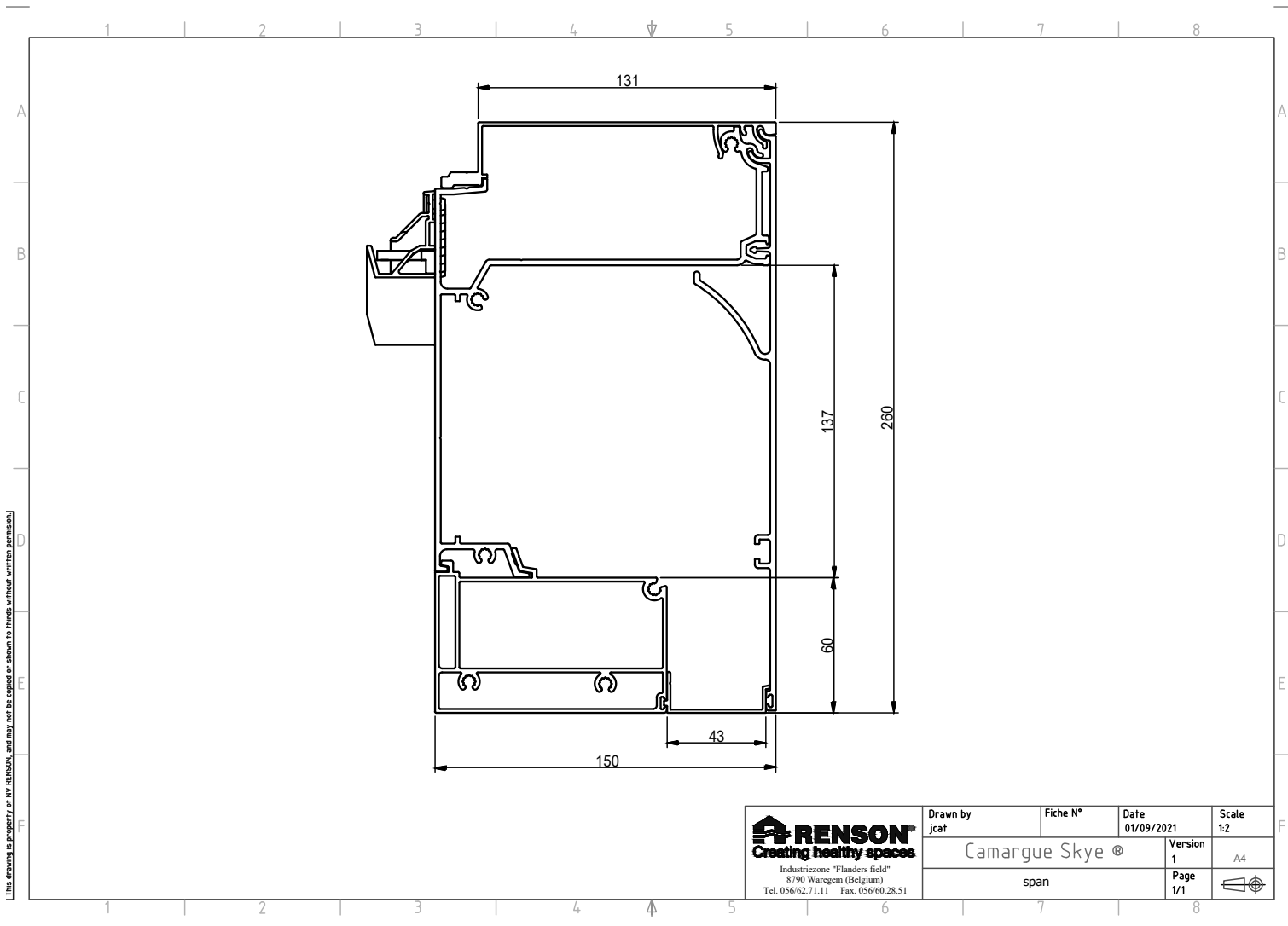

Download this drawing DWG

Download this drawing PDF

Camargue Skye - COUPLE SPAN SECTION

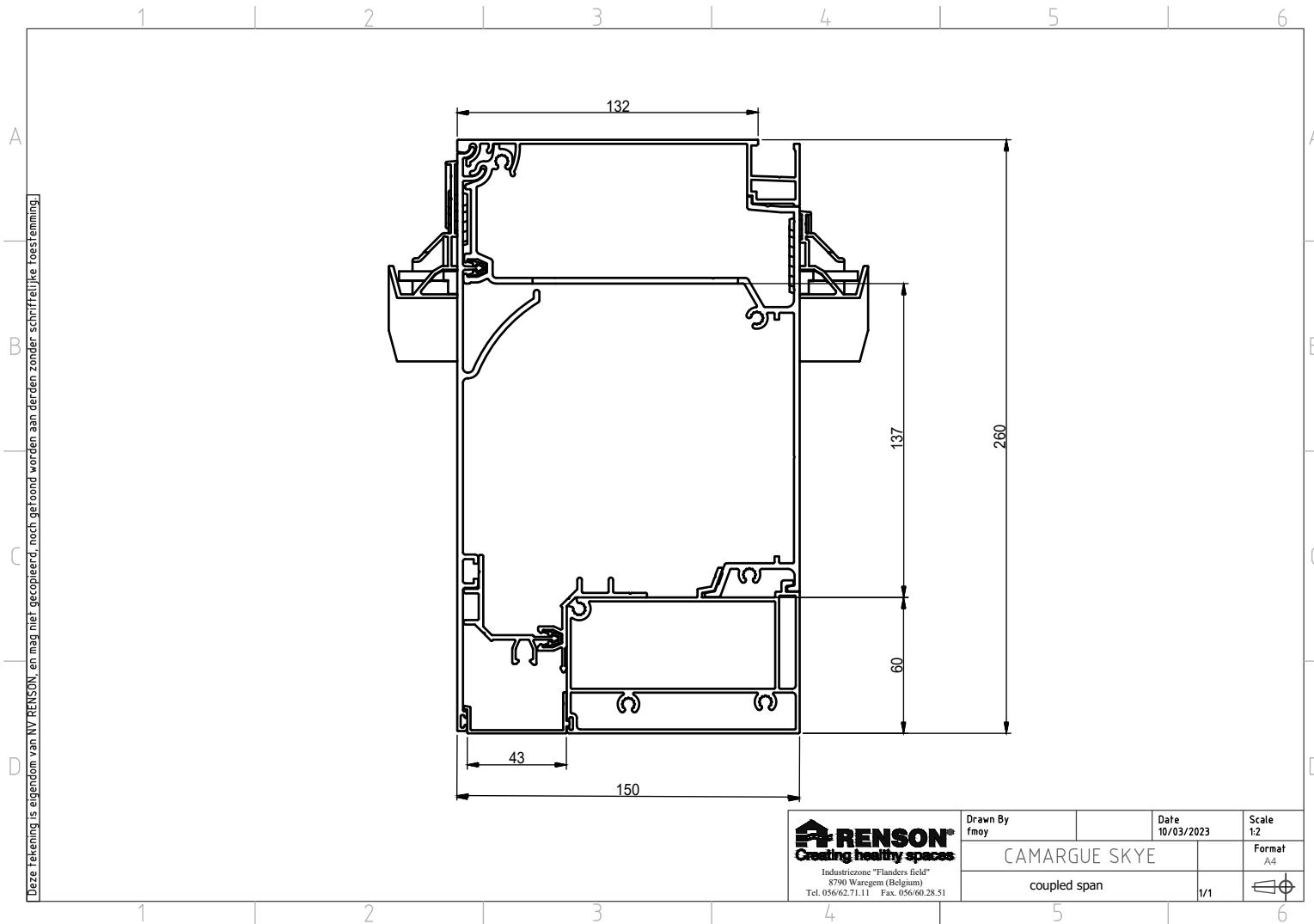

Download this drawing DWG

Download this drawing PDF

Camargue Skye - PIVOT SECTION

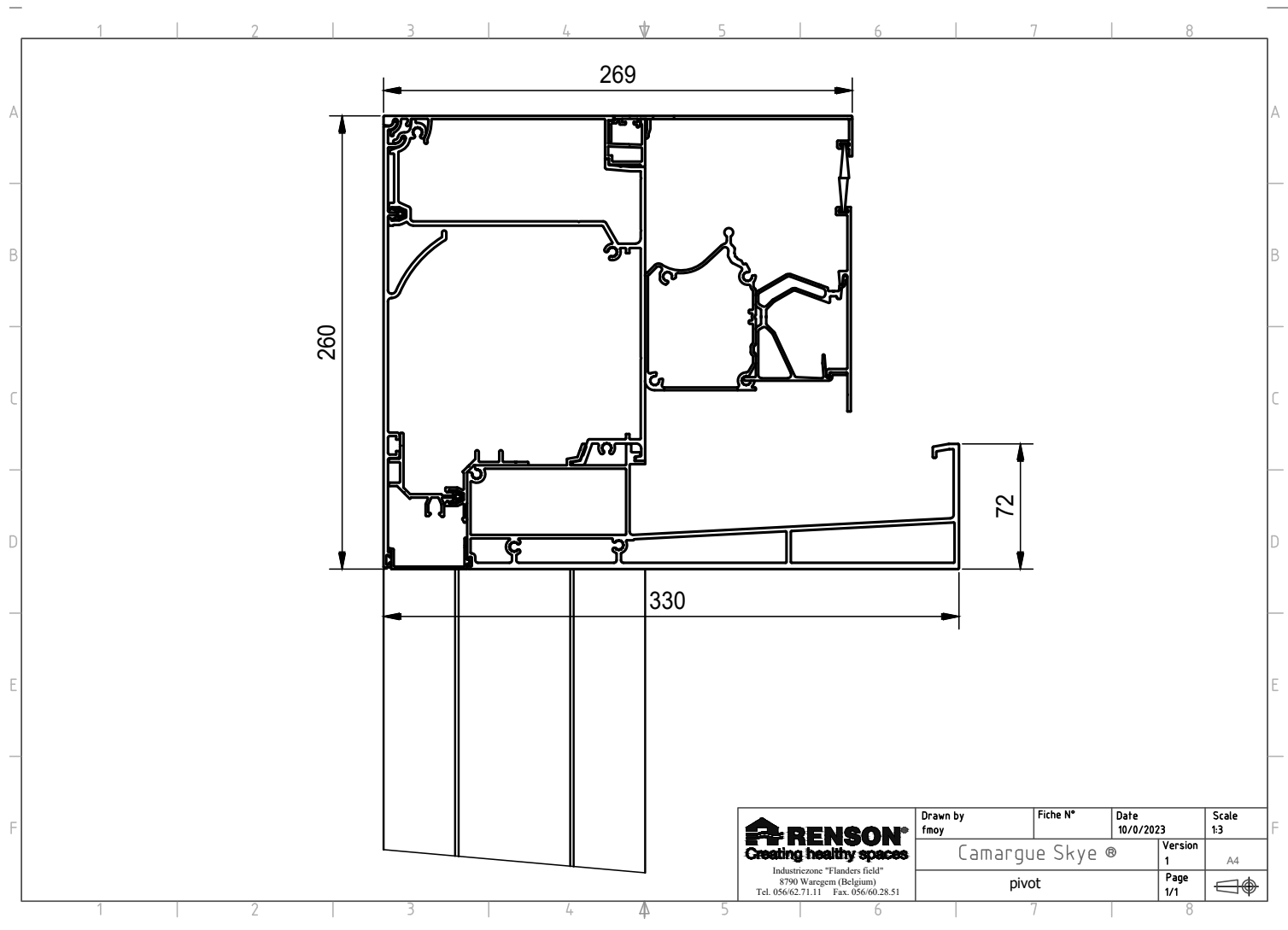



Download this drawing DWG

Download this drawing PDF

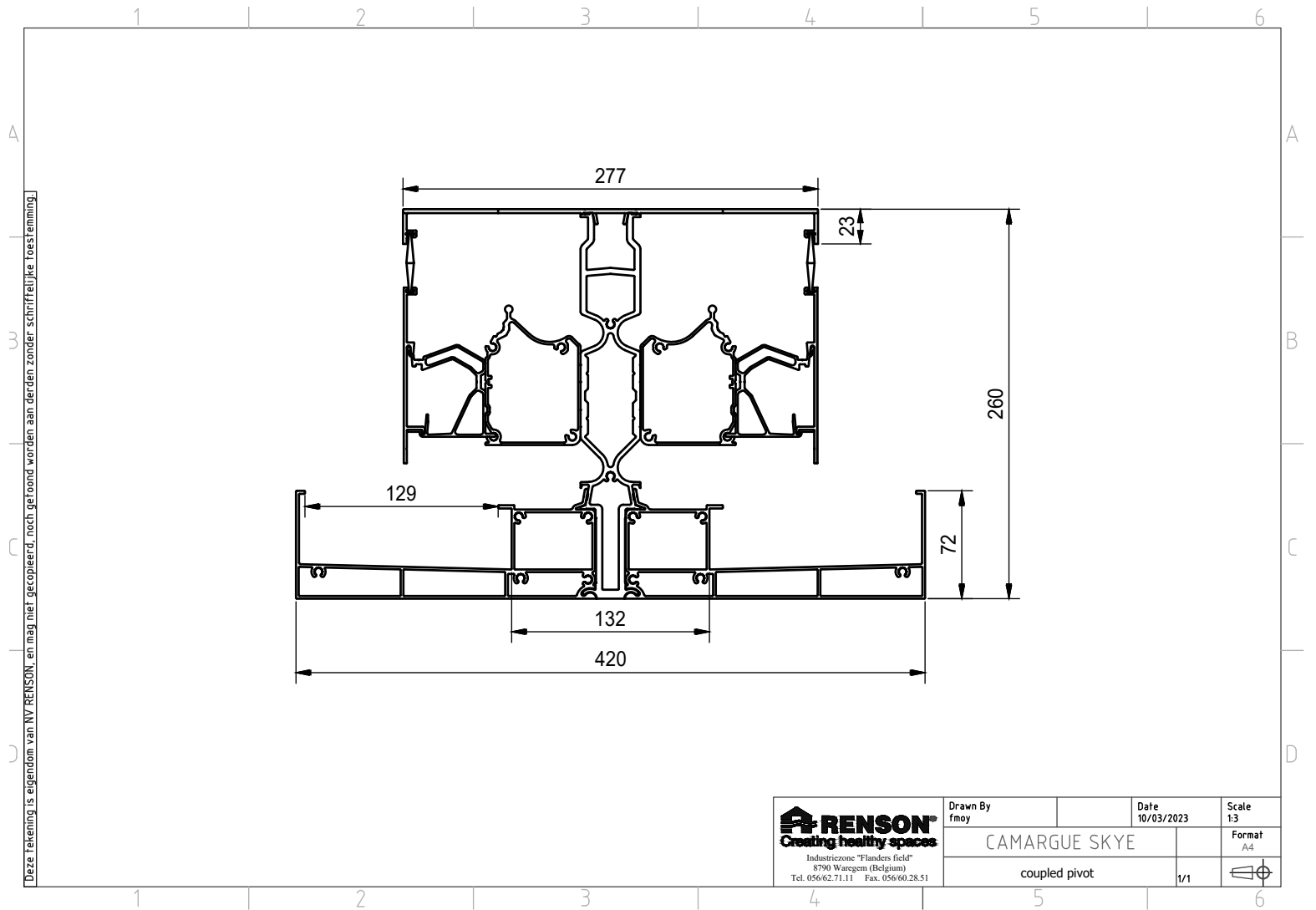
Camargue Skye - COUPLE PIVOT SECTION



Deze tekening is eigendom van NV RENSON, en mag niet gecopieerd, noch getoond worden aan derden zonder schriftelijke toestemming.

 Industriezone "Flanders Field" 8790 Waegem (Belgium) Tel. 056.62.71.11 Fax. 056.60.28.51	Drawn By fmoj	Date 10/03/2023	Scale 1:3
	CAMARGUE SKYE		Format A4
coupled pivot		1/1	

Download this drawing DWG

Download this drawing PDF

Camargue Skye - WALL FIXATION

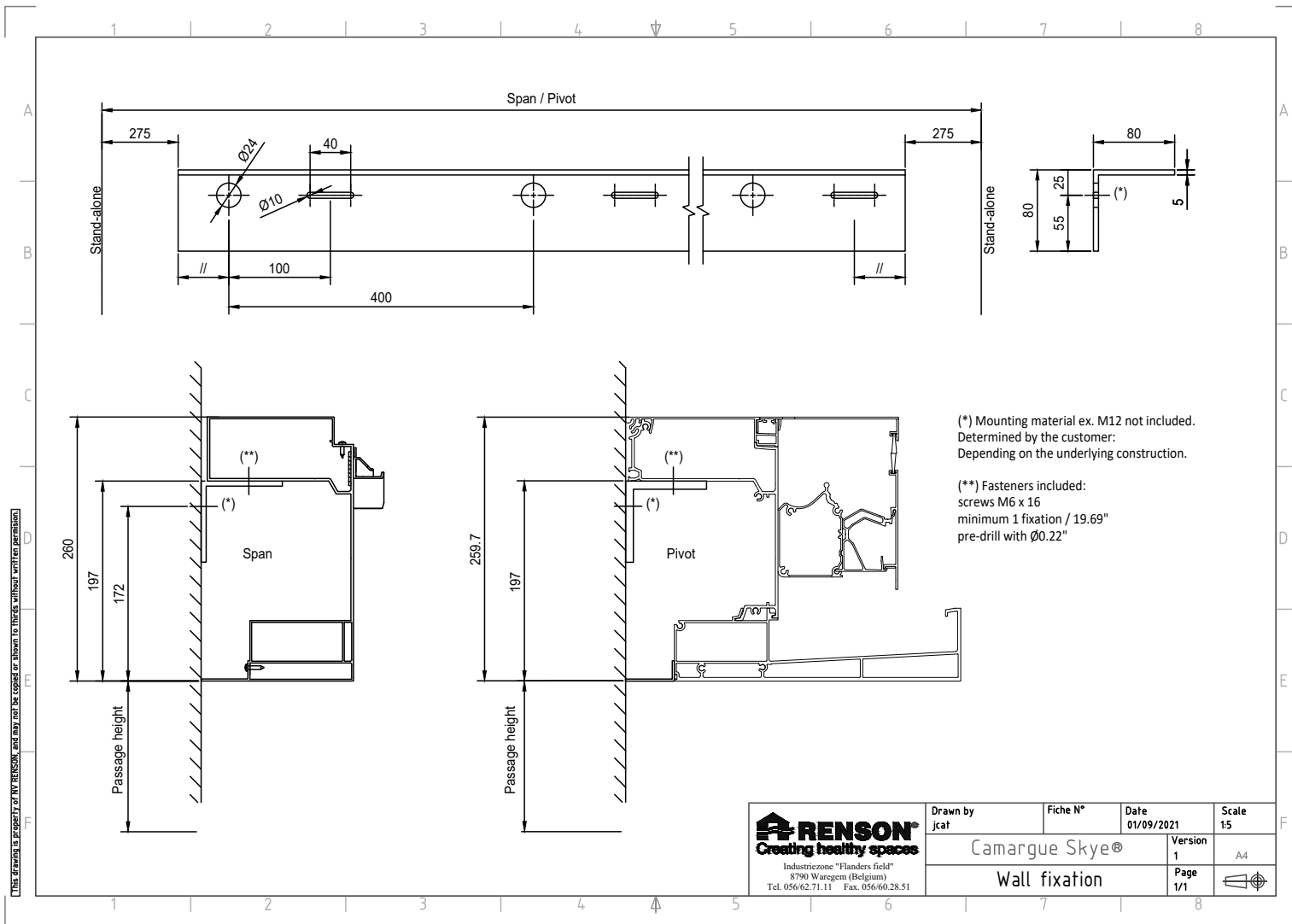

Download this drawing DWG

Download this drawing PDF

Camargue Skye - VISIBLE MOUNTING BASE

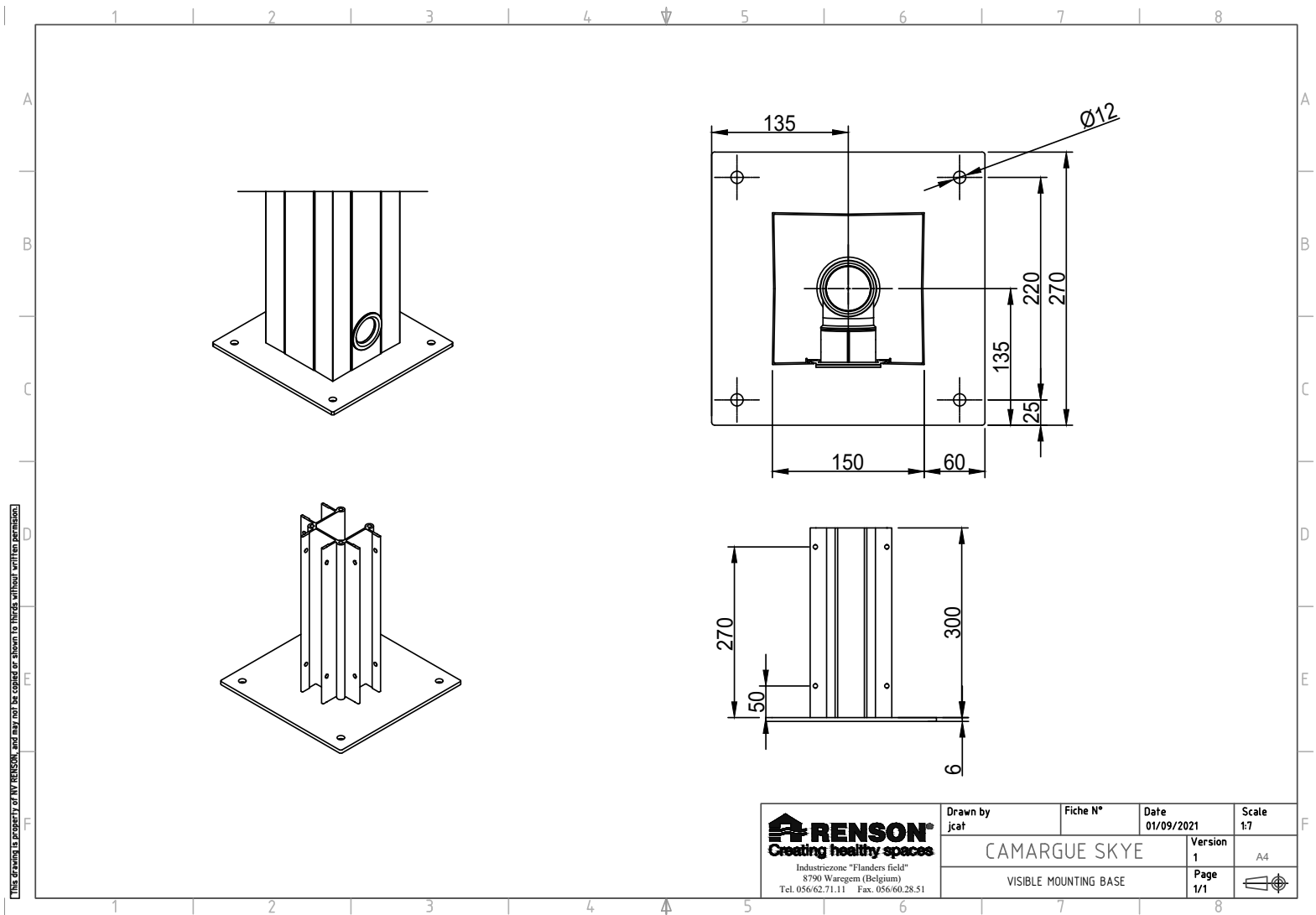



Download this drawing DWG

Download this drawing PDF

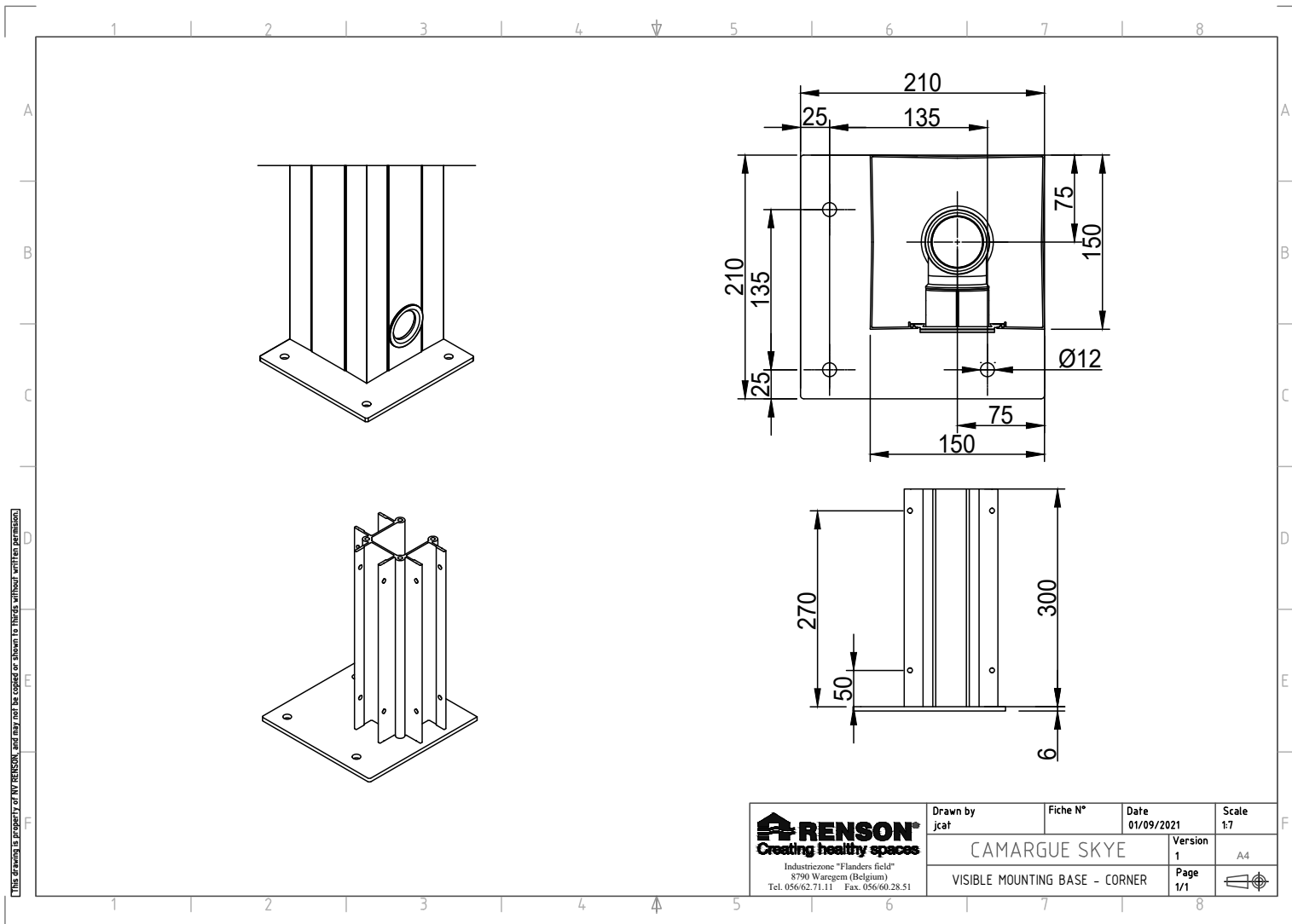
Camargue Skye - VISIBLE MOUNTING BASE CORNER



This drawing is property of NV RENSON and may not be copied or shown to third without written permission.

 Creating healthy spaces Industriezone "Flanders field" 8790 Waregem (Belgium) Tel. 056/62.71.11 Fax. 056/60.28.51	Drawn by jcat	Fiche N°	Date 01/09/2021	Scale 1:7	
	CAMARGUE SKYE			Version 1	A4
VISIBLE MOUNTING BASE - CORNER				Page 1/1	

Download this drawing DWG

Download this drawing PDF

Camargue Skye - INVISIBLE MOUNTING BASE

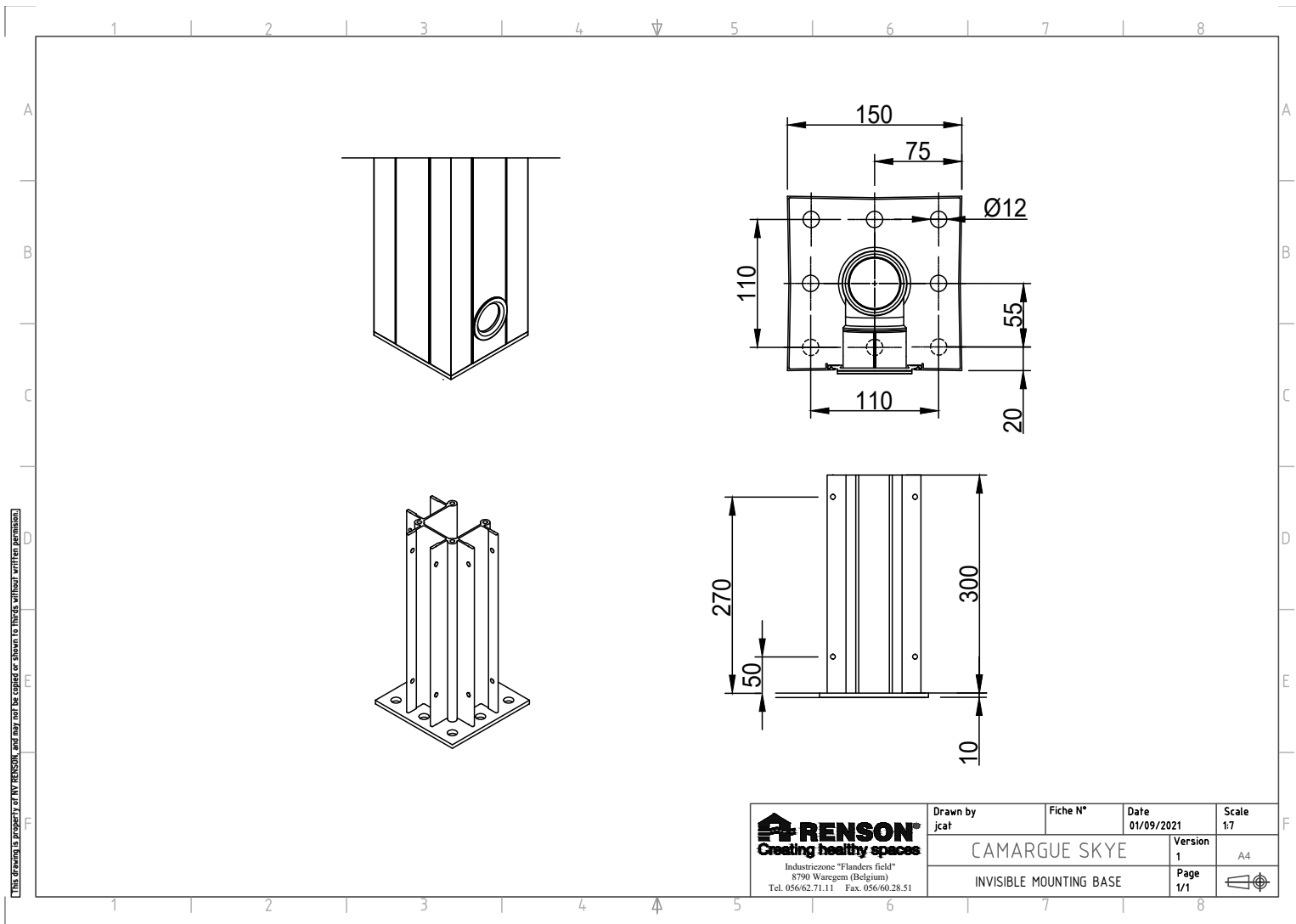

Download this drawing DWG

Download this drawing PDF

Camargue Skye - VISIBLE REINFORCED MOUNTING BASE

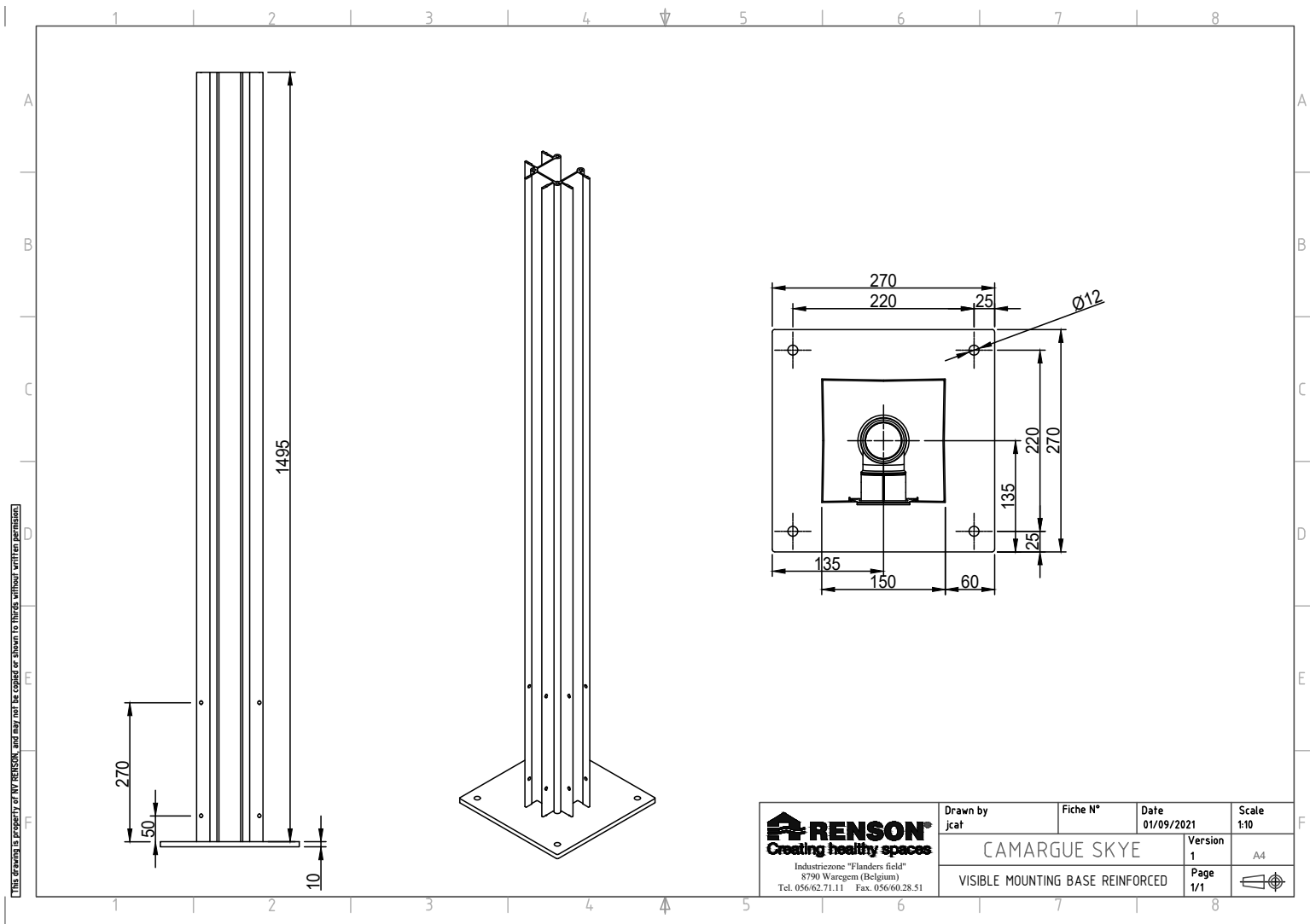

This drawing is property of NV RENSON, and may not be copied or shown to third without written permission

Download this drawing DWG

Download this drawing PDF

Camargue Skye - VISIBLE REINFORCED MOUNTING BASE - CORNER

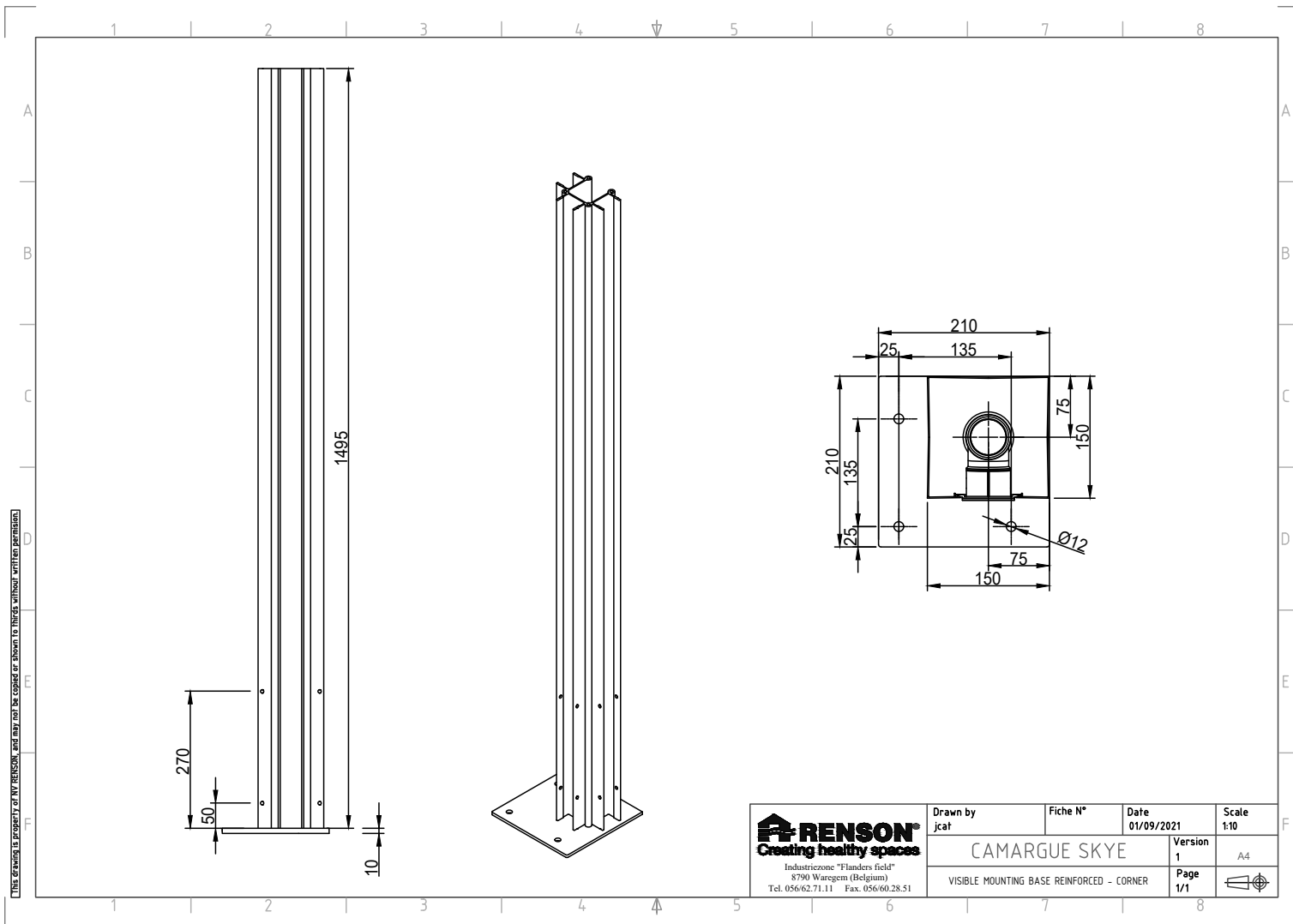

THIS DRAWING IS PROPERTY OF INY RENSON, and may not be copied or shown to third without written permission.

 RENSON Creating healthy spaces Industriezone "Flanders field" 8790 Waregem (Belgium) Tel. 056/62.71.11 Fax. 056/60.28.51	Drawn by jcat	Fiche N°	Date 01/09/2021	Scale 1:10	
	CAMARGUE SKYE			Version 1	A4
	VISIBLE MOUNTING BASE REINFORCED - CORNER			Page 1/1	

Download this drawing DWG

Download this drawing PDF

Camargue Skye - INVISIBLE REINFORCED MOUNTING BASE

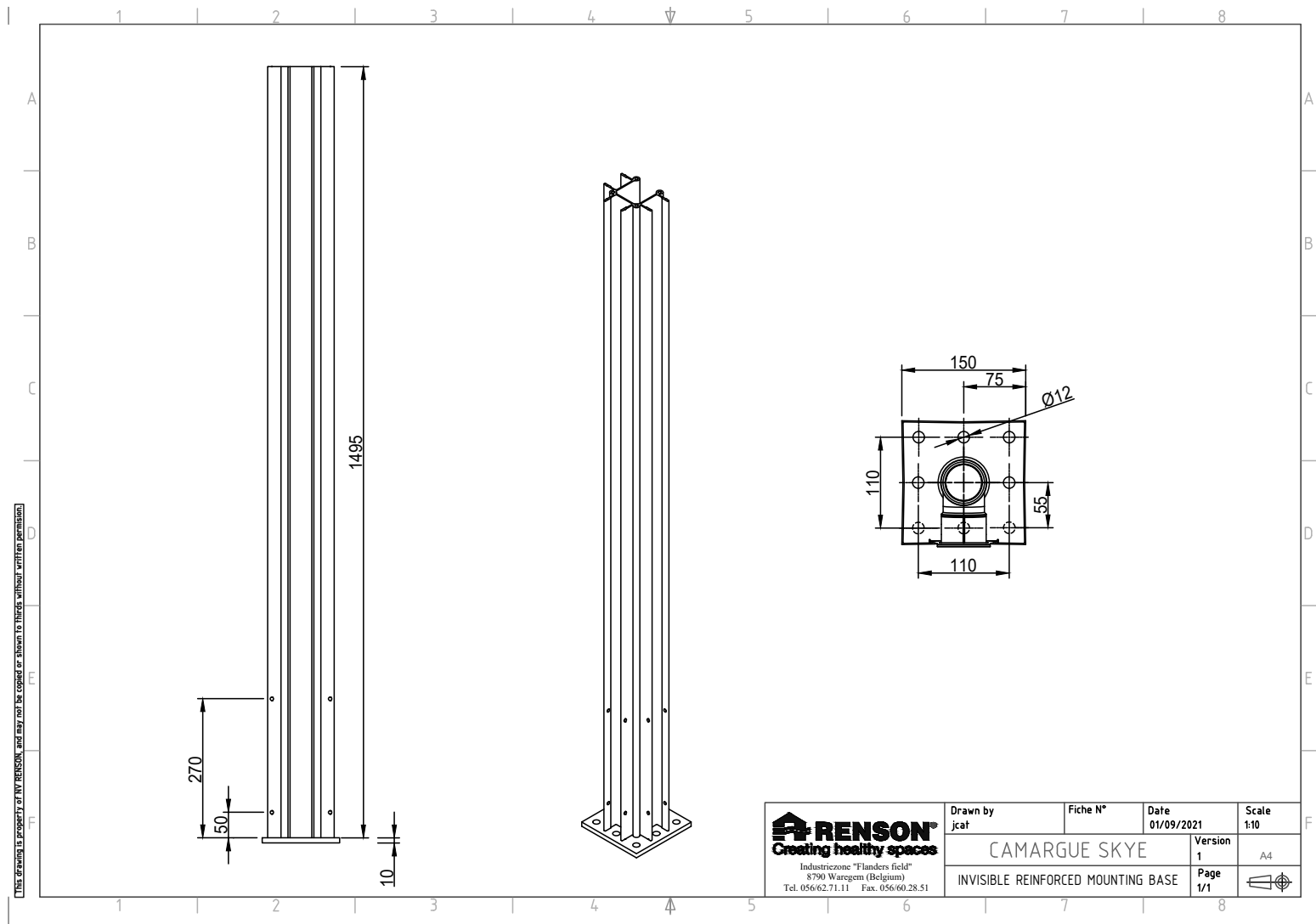

Download this drawing DWG

Download this drawing PDF

Camargue Skye - WATER DRAINAGE

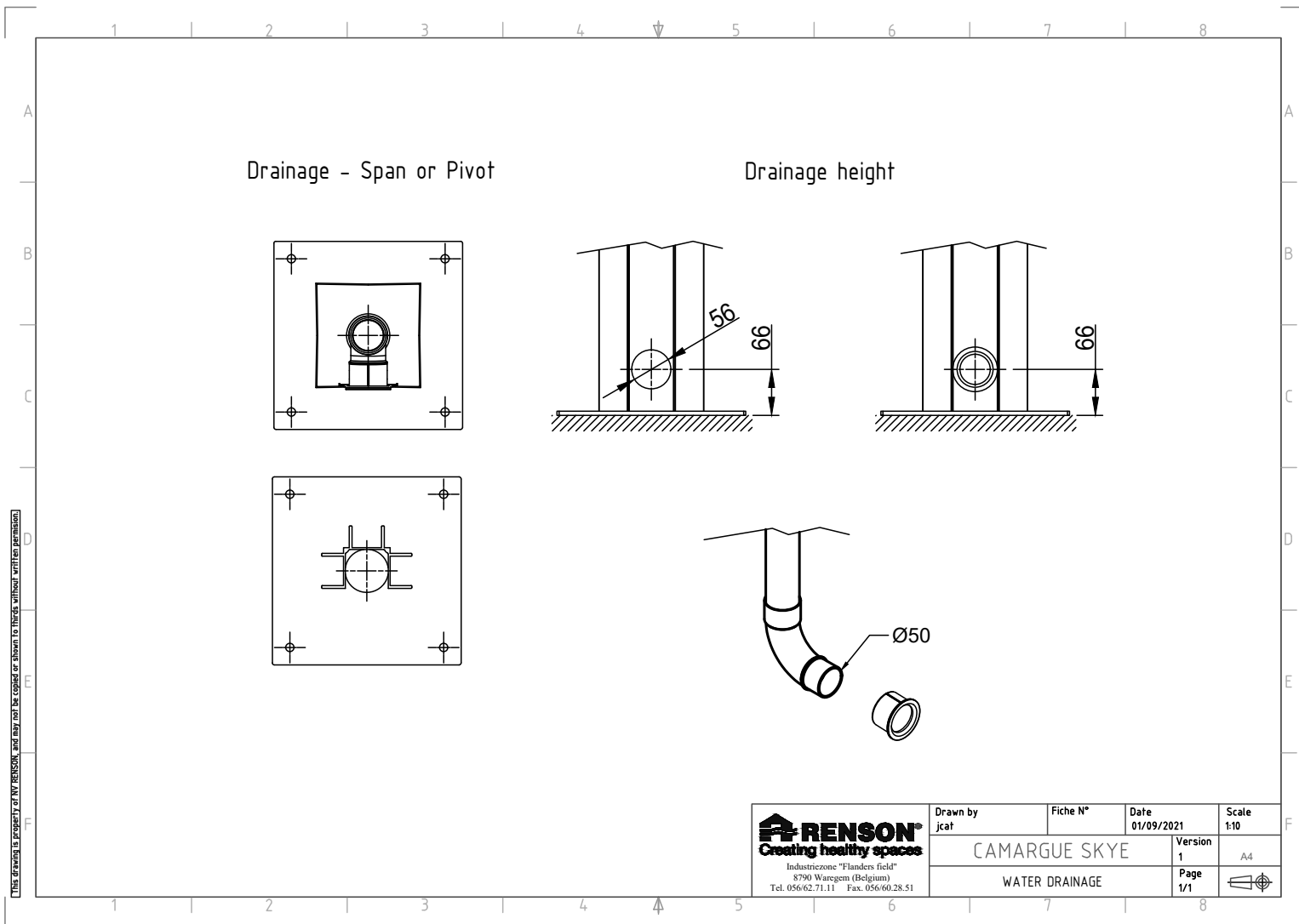



Download this drawing DWG

Download this drawing PDF

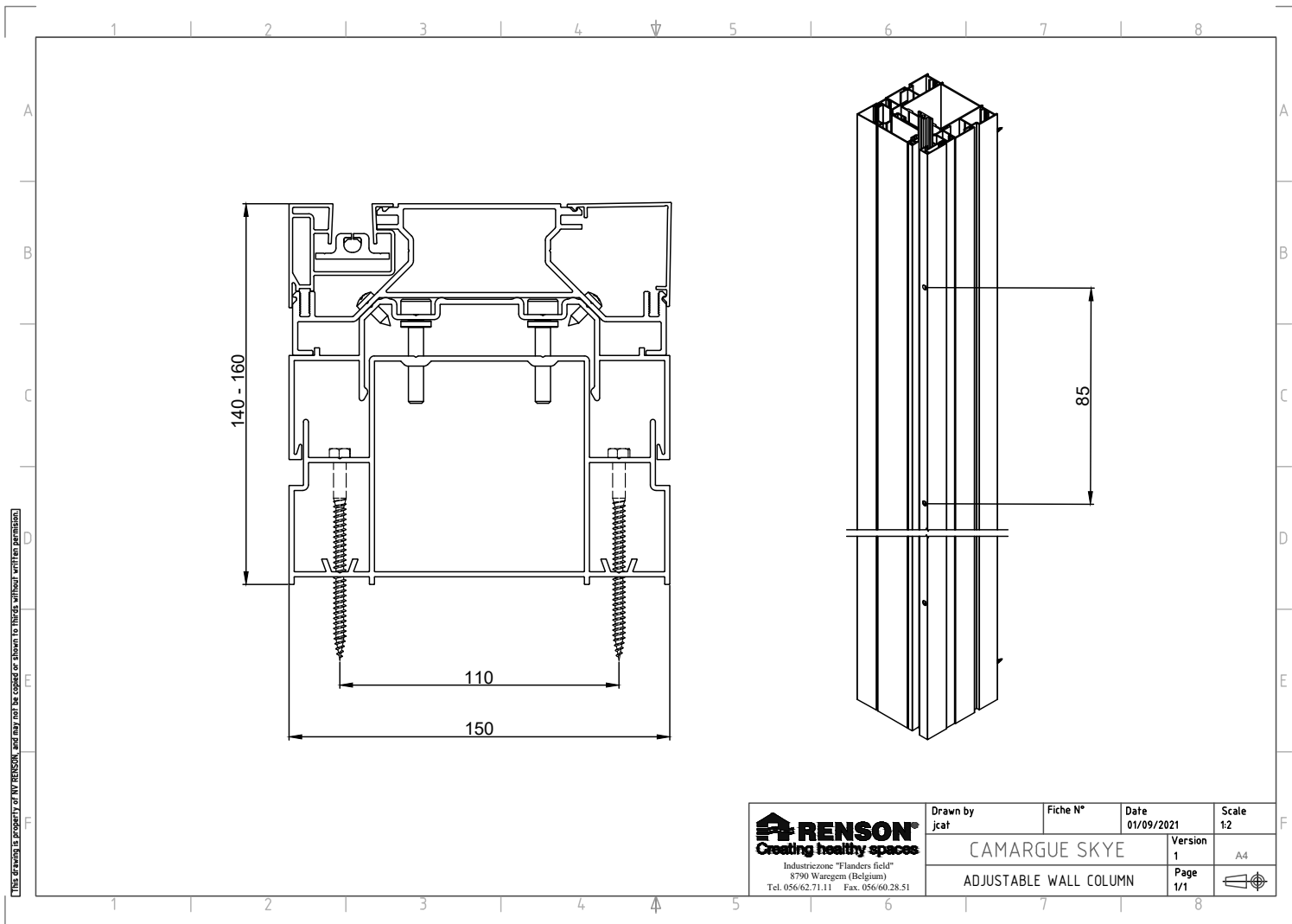
Camargue Skye - ADJUSTABLE WALL COLUMN



 RENSON Creating healthy spaces Industriezone "Flanders field" 8790 Waregem (Belgium) Tel. 056/62.71.11 Fax. 056/60.28.51	Drawn by jcat	Fiche N°	Date 01/09/2021	Scale 1:2	
	CAMARGUE SKYE			Version 1	A4
ADJUSTABLE WALL COLUMN				Page 1/1	

Download this drawing DWG

Download this drawing PDF

Camargue Skye - INTEGRATED FIXSCREEN - STAND ALONE SPAN SIDE

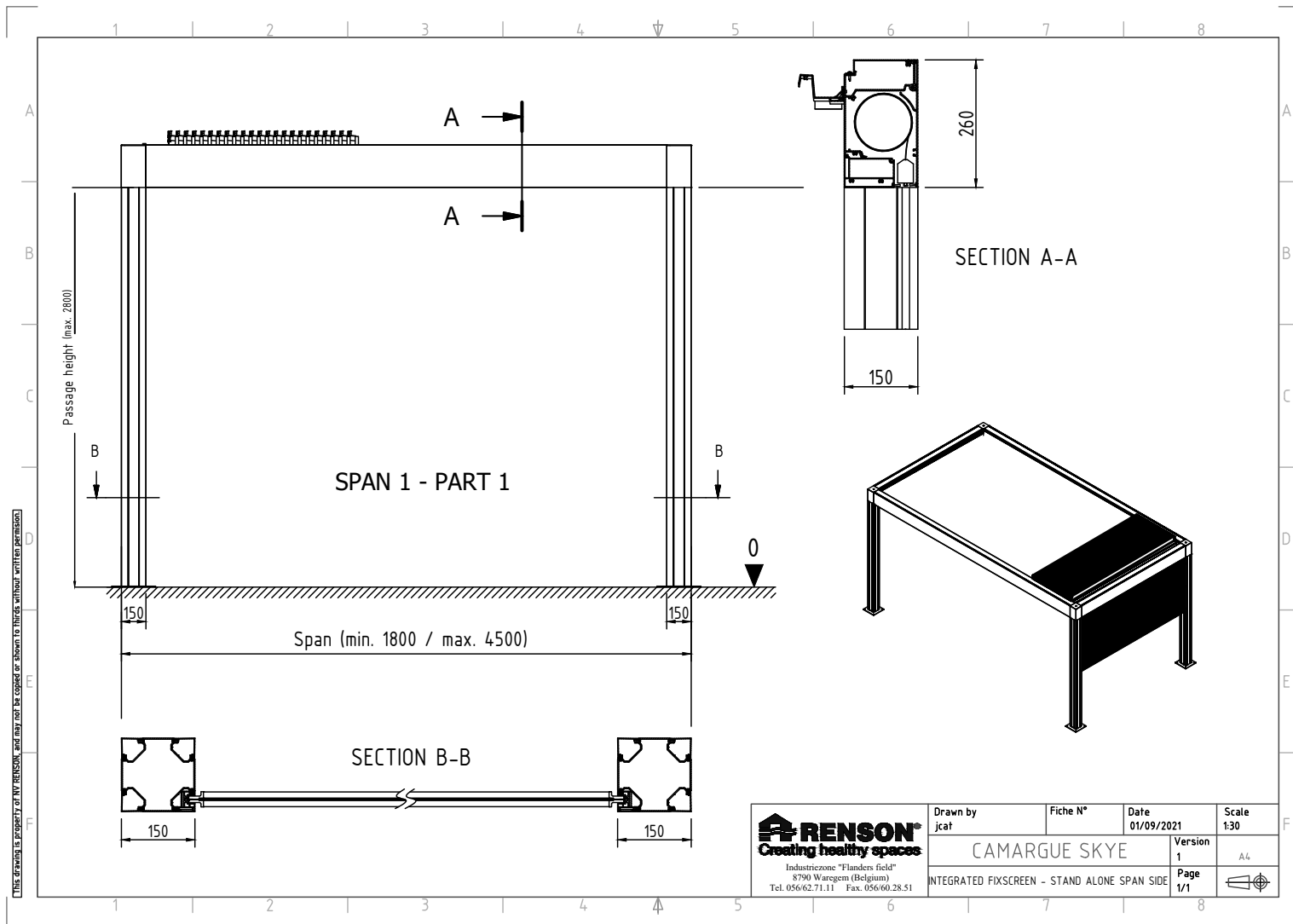

Download this drawing DWG

Download this drawing PDF

Camargue Skye - INTEGRATED FIXSCREEN - STAND ALONE PIVOT SIDE

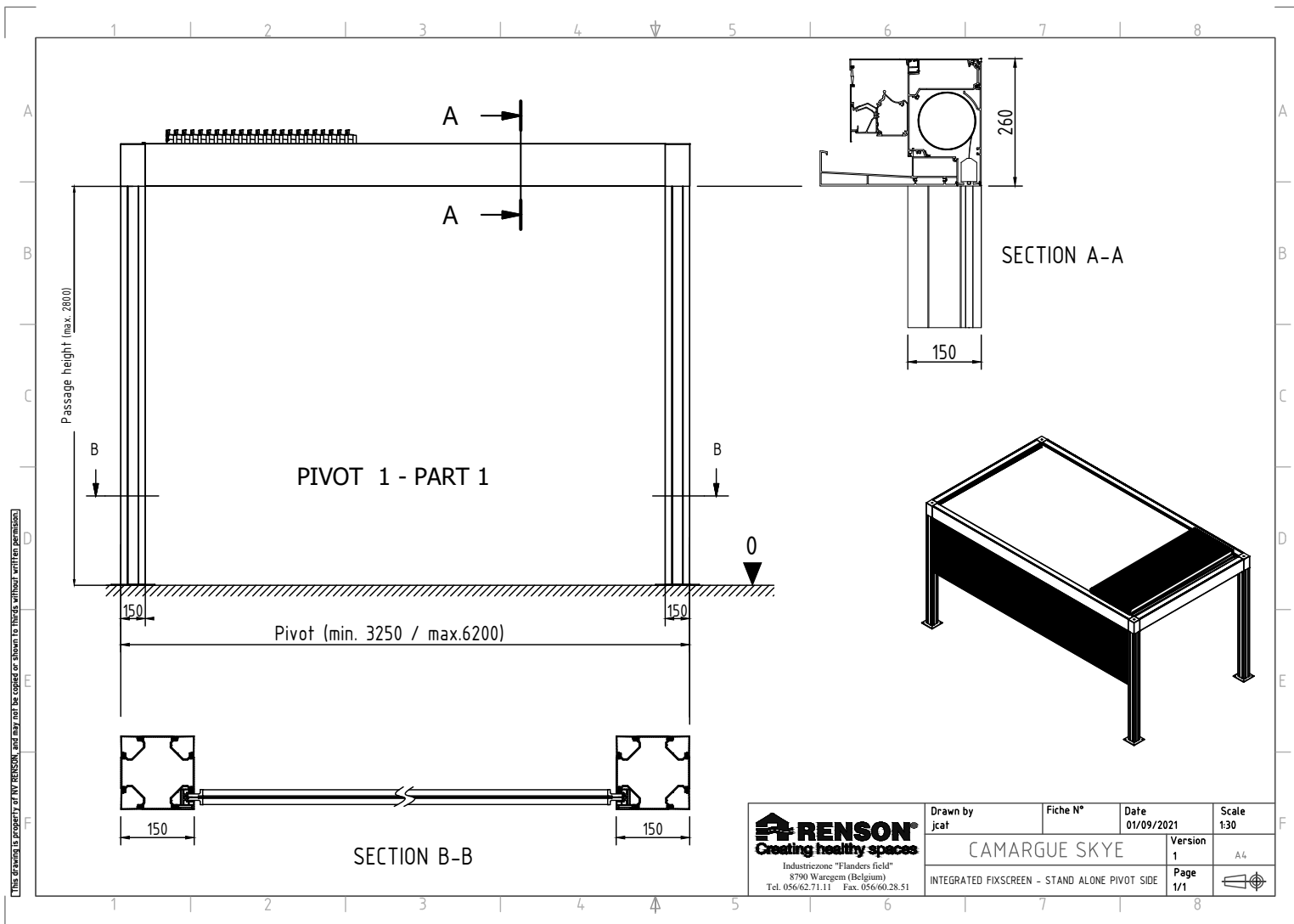

Download this drawing DWG

Download this drawing PDF

Camargue Skye - INTEGRATED FIXSCREEN - FACADE MOUNTING PIVOT

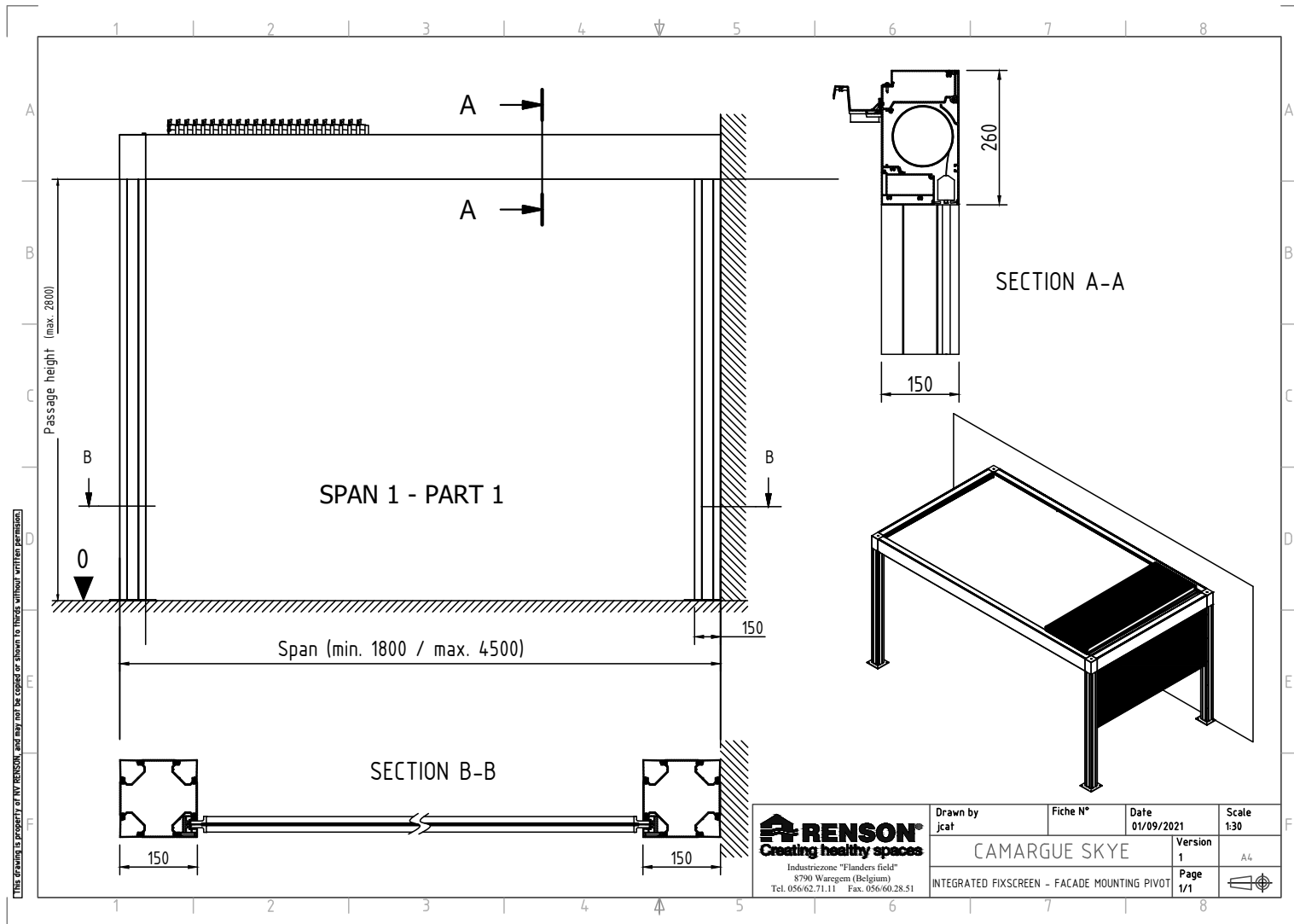

RENSON Creating healthy spaces Industriezone "Flanders field" 8790 Waregem (Belgium) Tel. 056/62.71.11 - Fax. 056/60.28.51	Drawn by jcat	Fiche N°	Date 01/09/2021	Scale 1:30	
	CAMARGUE SKYE			Version 1	A4
INTEGRATED FIXSCREEN - FACADE MOUNTING PIVOT				Page 1/1	

Download this drawing DWG

Download this drawing PDF

Camargue Skye - OUTDOOR LOGGIA - FIXED PANELS

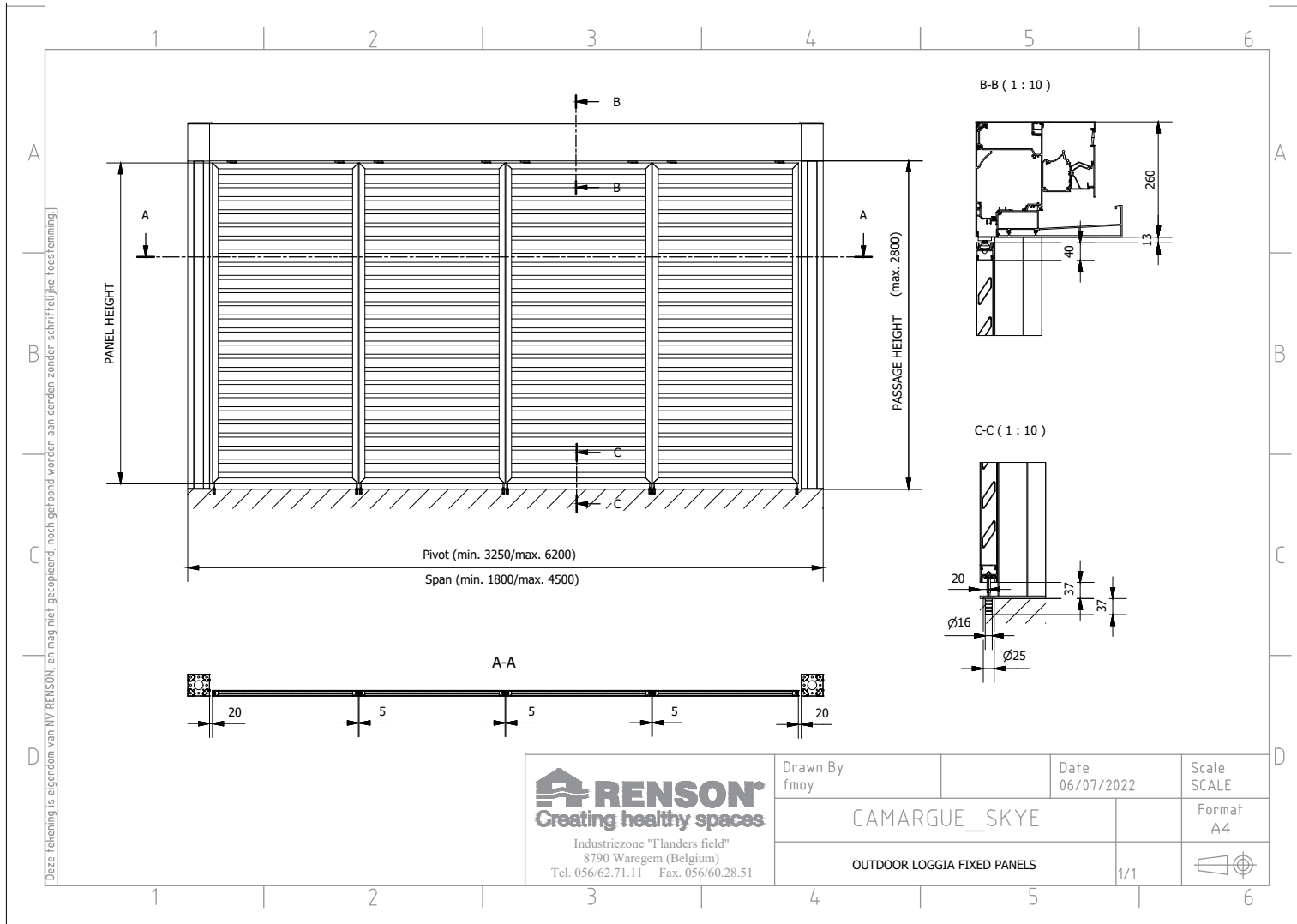

Download this
drawing DWG

Download this
drawing PDF

Camargue Skye - OUTDOOR LOGGIA - 2 SLIDING PANELS

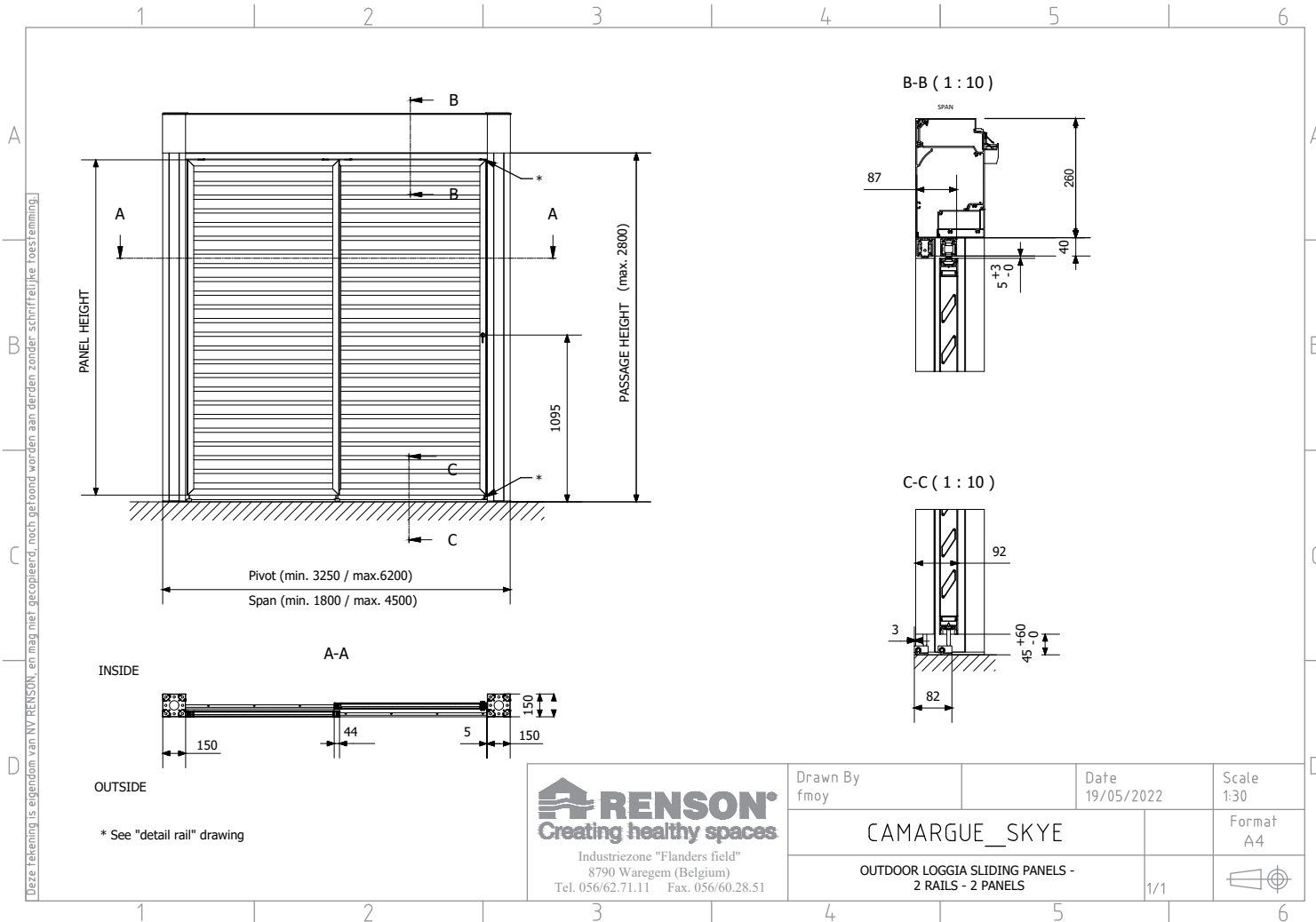

Download this
drawing DWG

Download this
drawing PDF

Camargue Skye - OUTDOOR LOGGIA - 4 SLIDING PANELS

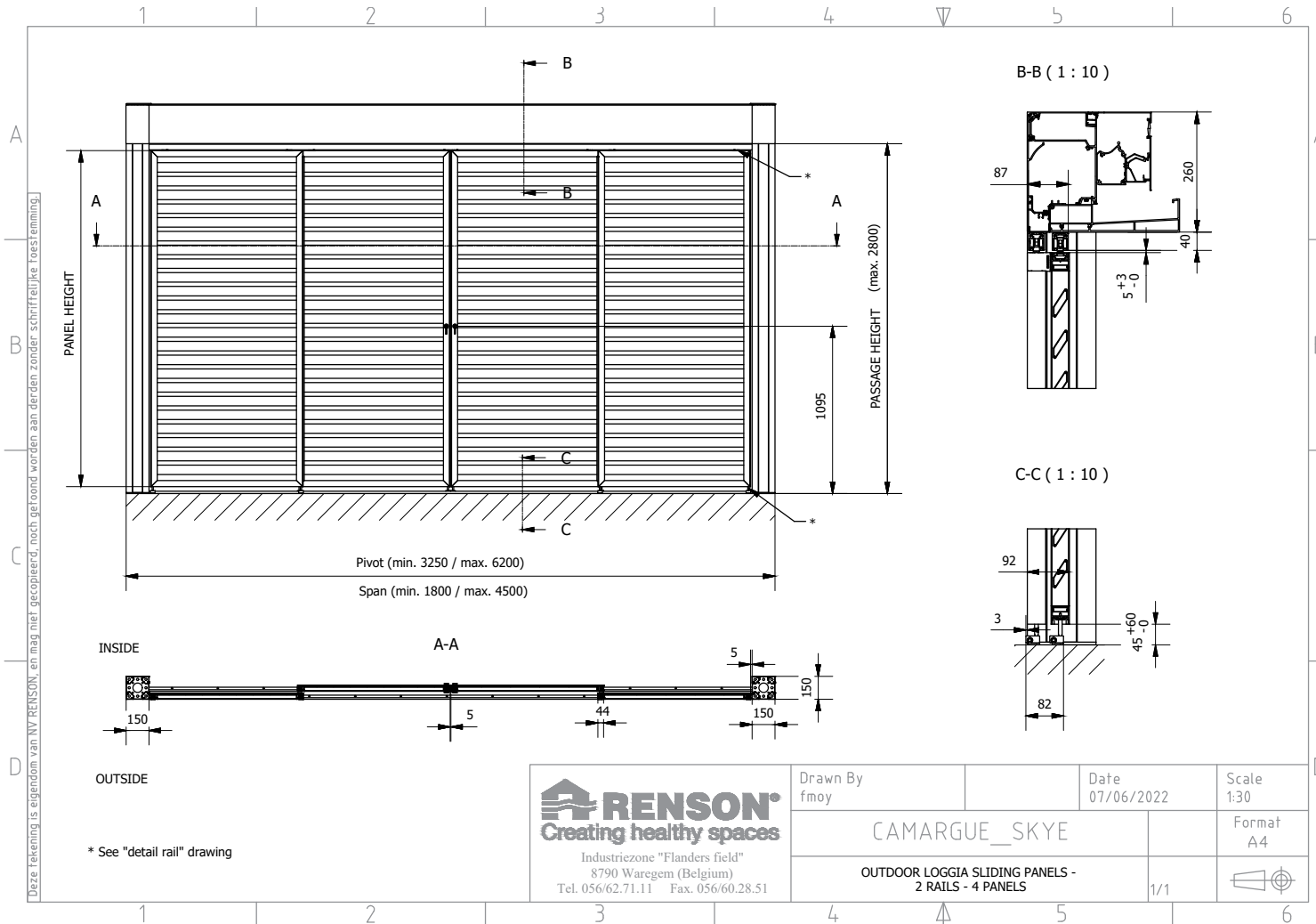

Download this drawing DWG

Download this drawing PDF

Camargue Skye - OUTDOOR LOGGIA - 6 SLIDING PANELS

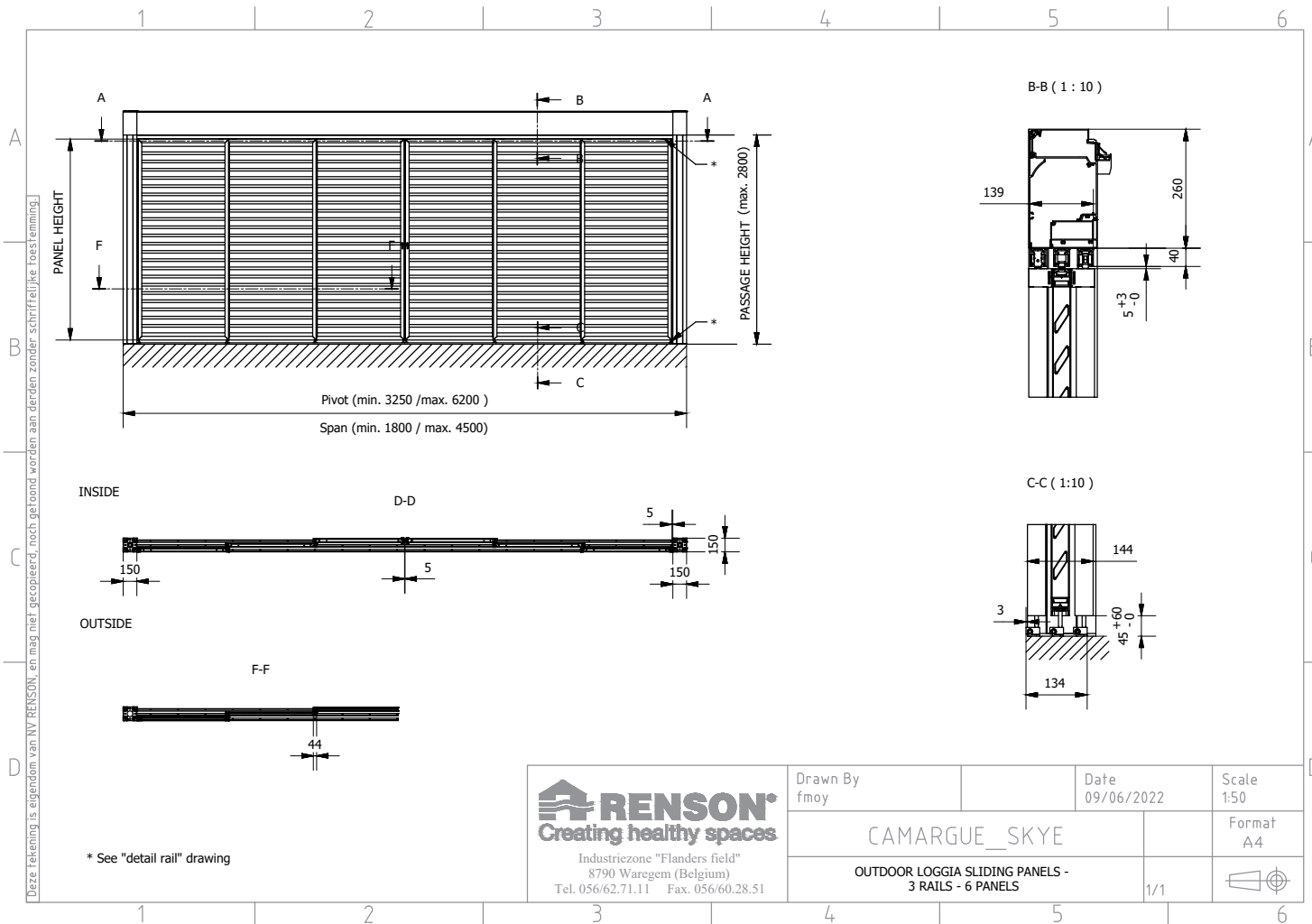

Download this
drawing DWG

Download this
drawing PDF

Camargue Skye - GLASS SLIDING PANELS - STAND ALONE WITH 4 TRACKS

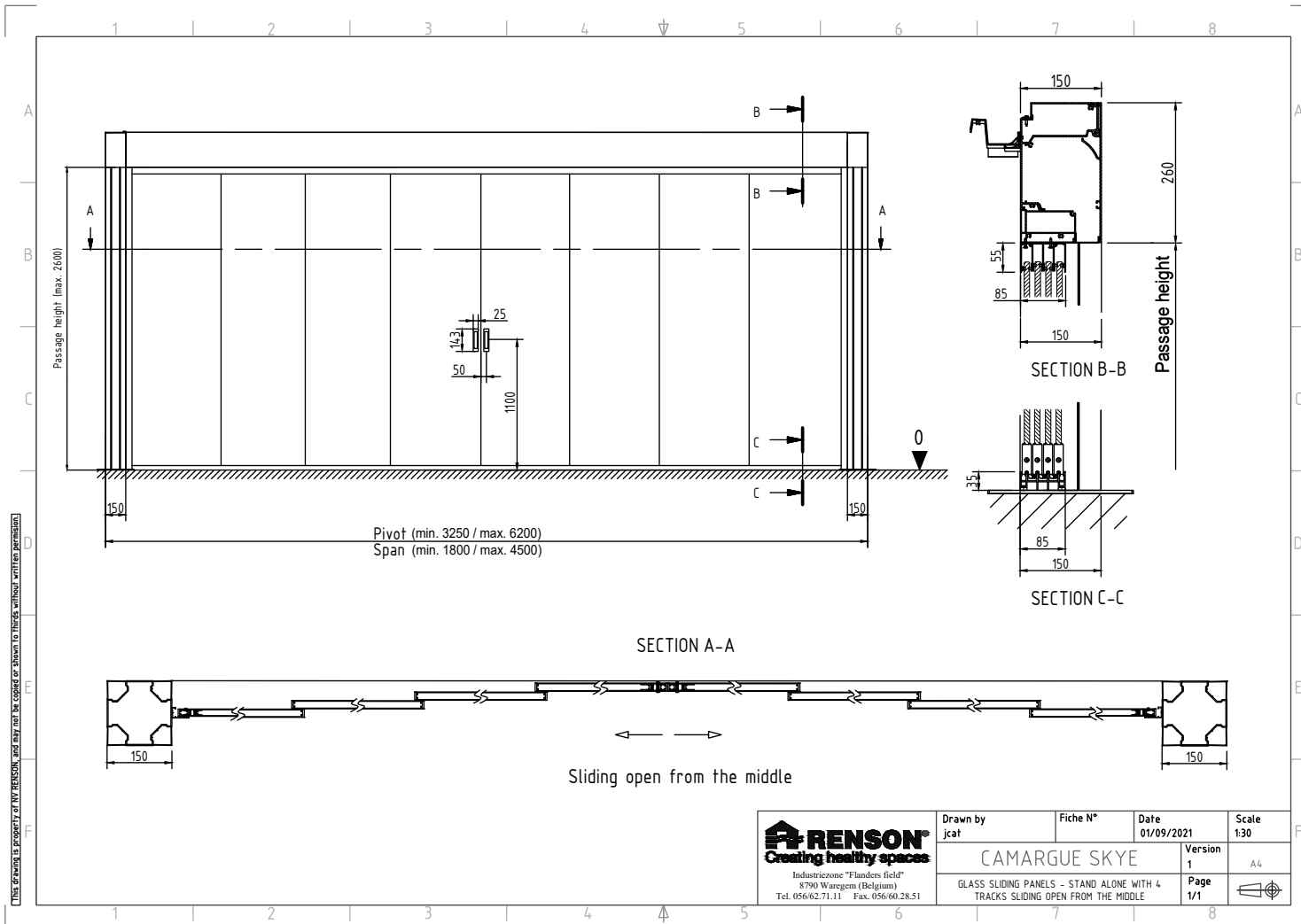

This drawing is property of NV RENSON, and may not be copied or shown to third parties without written permission.

RENSON
 Creating healthy spaces
 Industriezone "Flanders field"
 8790 Waregem (Belgium)
 Tel. 056/62.71.11 Fax. 056/60.28.51

Drawn by jcat	Fiche N°	Date 01/09/2021	Scale 1:30
CAMARGUE SKYE			Version 1
GLASS SLIDING PANELS - STAND ALONE WITH 4 TRACKS SLIDING OPEN FROM THE MIDDLE			Page 1/1
			A4

Download this drawing DWG

Download this drawing PDF

Camargue Skye - GLASS SLIDING PANELS - FACADE MOUNTING WITH 3 TRACKS

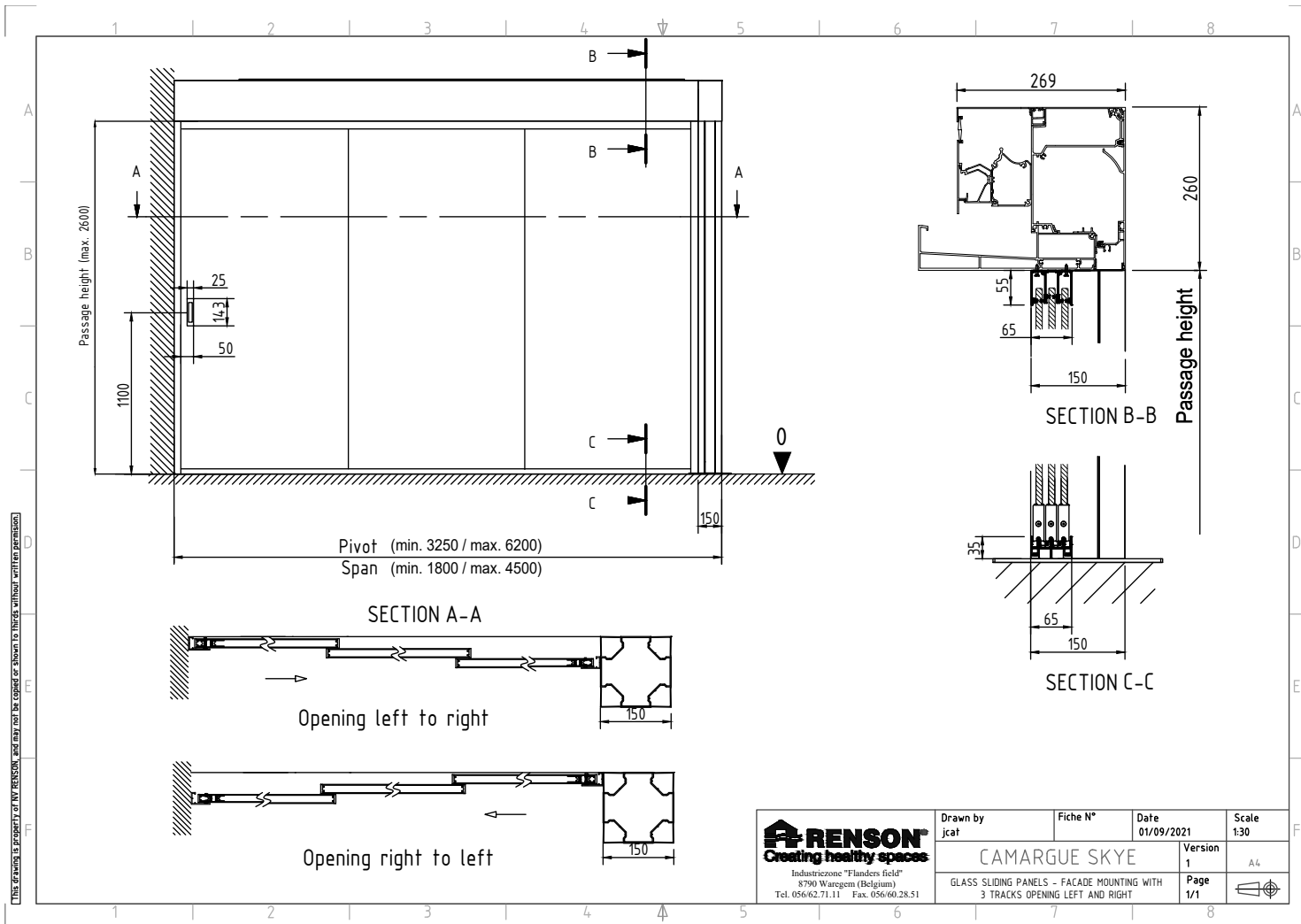

This drawing is property of NV RENSON, and may not be copied or shown to third without written permission.

Download this drawing DWG

Download this drawing PDF

Camargue Skye - GLASS SLIDING PANELS - STAND ALONE 5 TRACKS

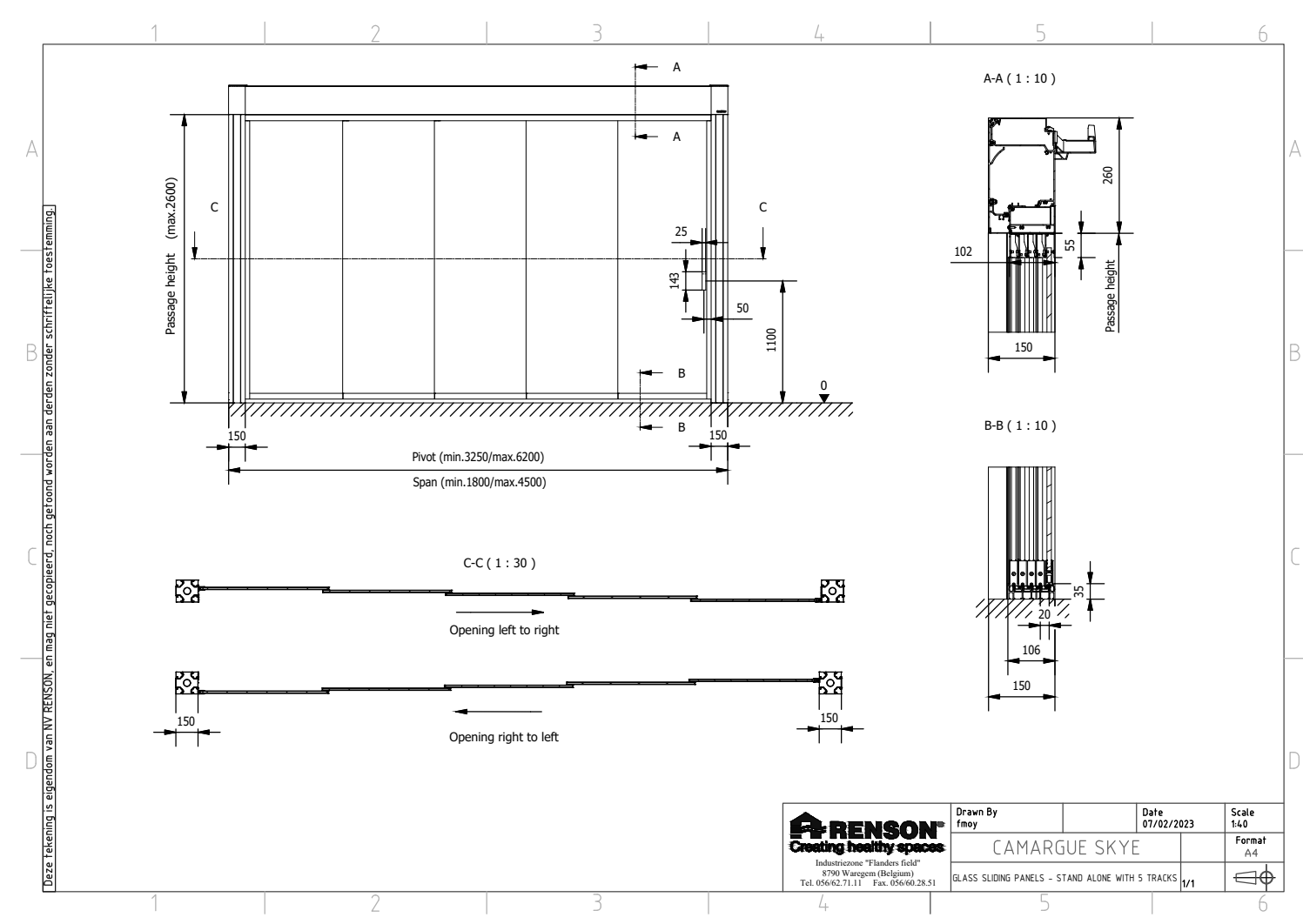

Download this drawing DWG

Download this drawing PDF

Camargue Skye - LINIUS WALL - DOUBLE SIDED

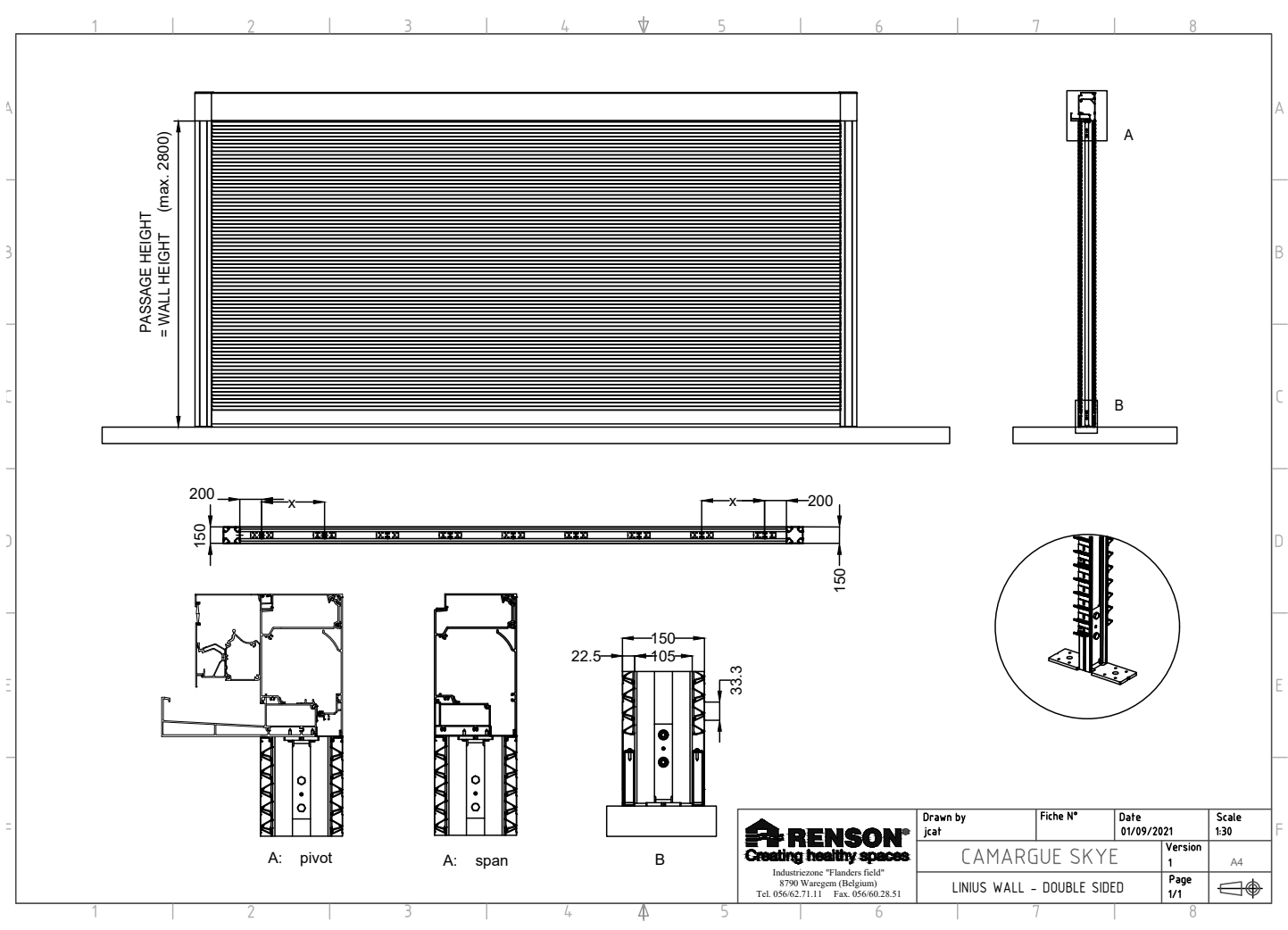

Download this drawing DWG

Download this drawing PDF

Camargue Skye - LINIUS WALL - SINGLE SIDED

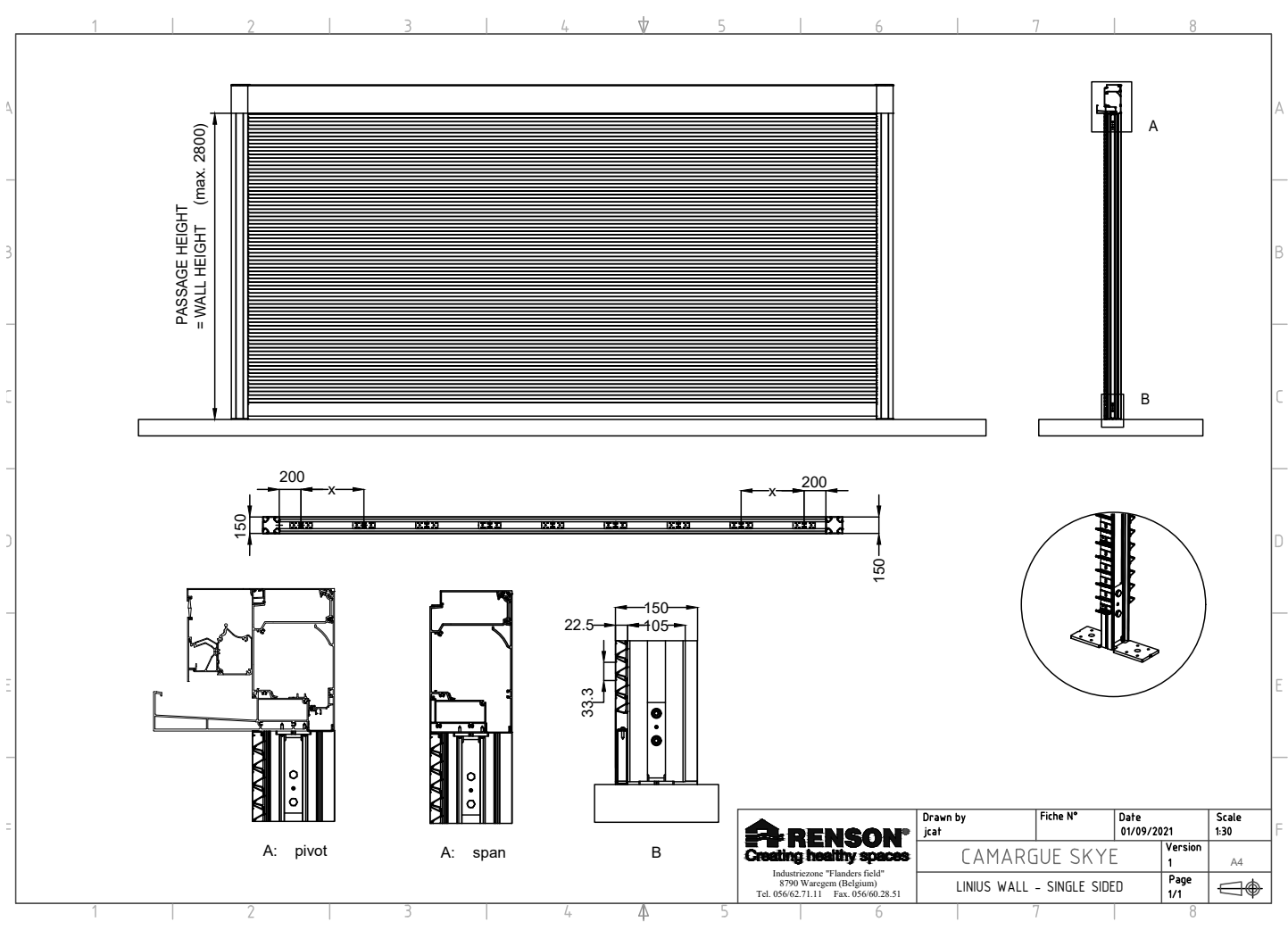

Download this drawing DWG

Download this drawing PDF

Camargue Skye - LINIUS WALL - DOUBLE SIDED AS RAILING

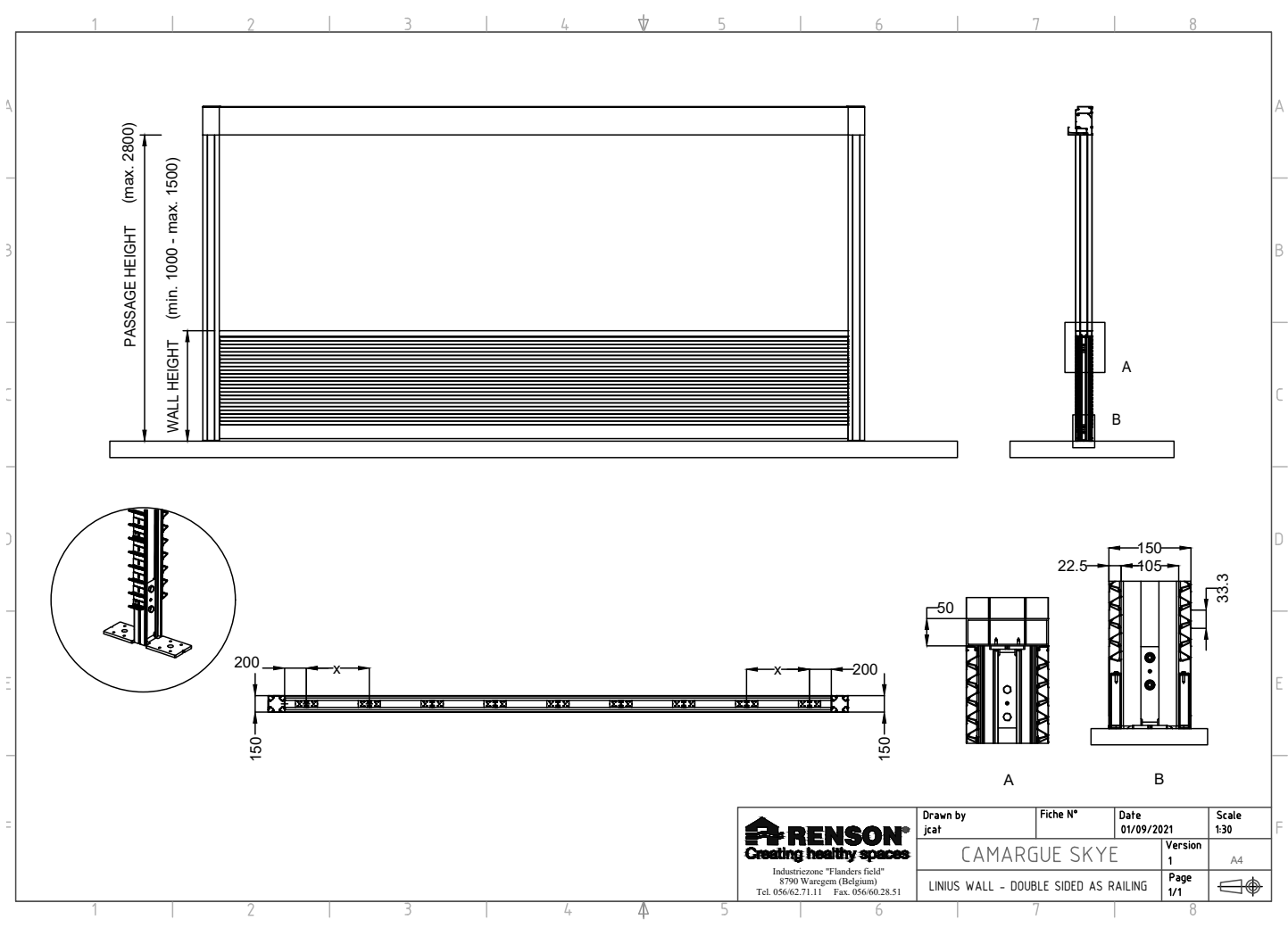

Download this drawing DWG

Download this drawing PDF

Camargue Skye - LINARTE WALL - LINARTE/CANVAS

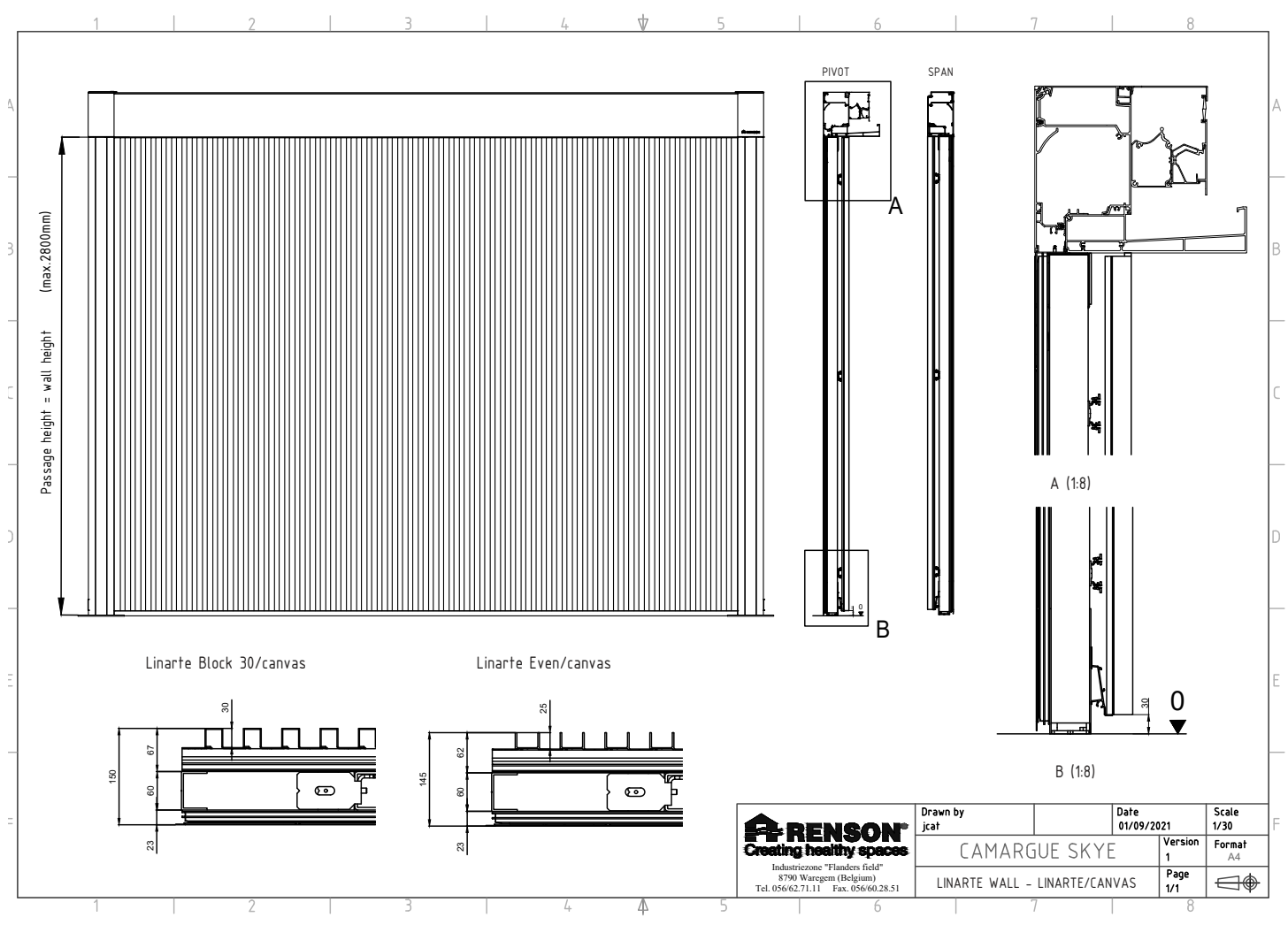

Download this drawing DWG

Download this drawing PDF

Camargue Skye - LINARTE WALL - LINARTE/WITHOUT FINISH

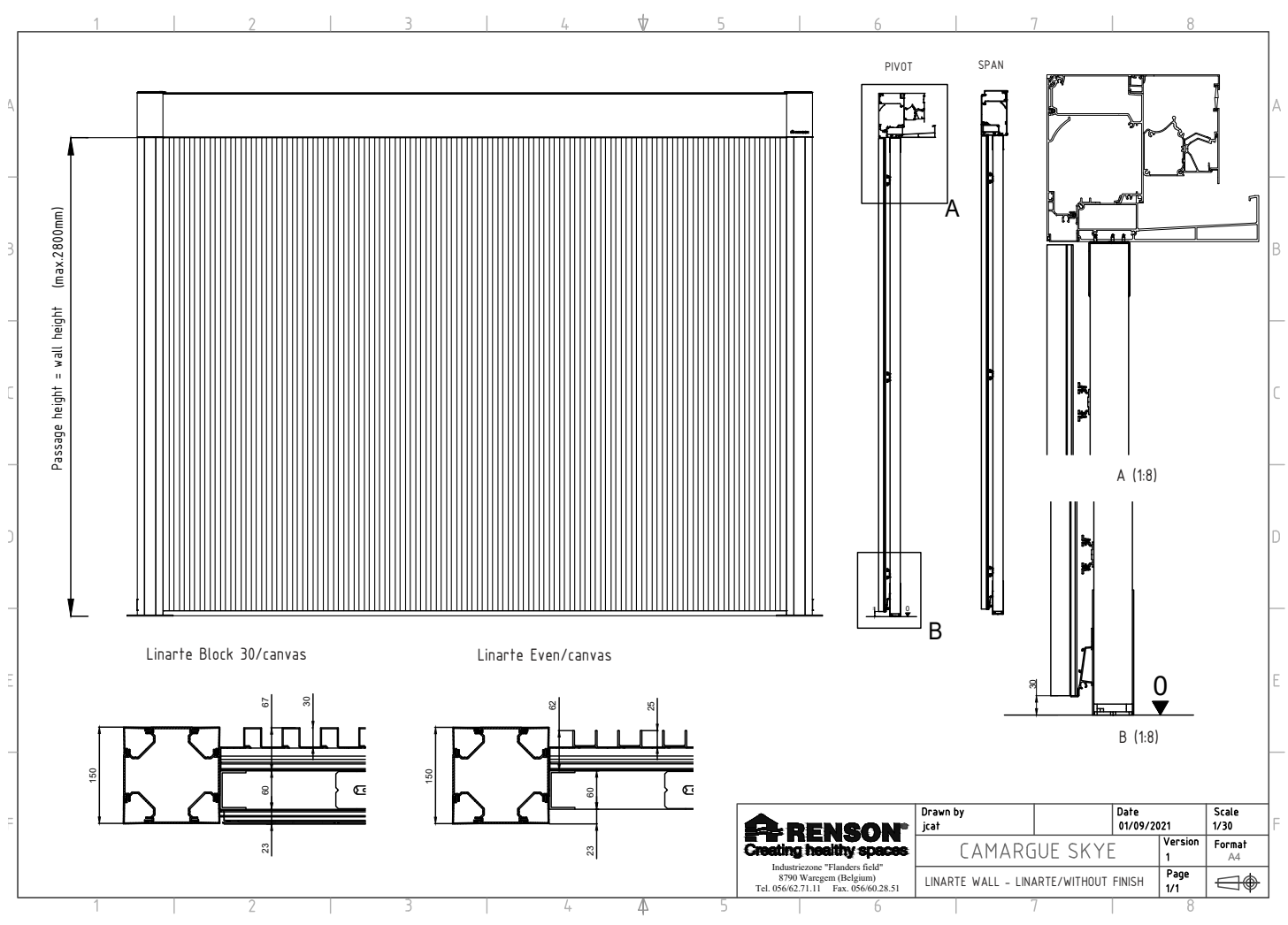

Download this drawing DWG

Download this drawing PDF